



# **RICAMBI PER CALDAIE, SCALDABAGNI E RADIATORI A GAS**

<b>Ricambi specifici per caldaie a gas</b>	<b>Pag. 2</b>
<b>Apparecchiature e schede elettroniche</b>	<b>Pag. 12</b>
<b>Resistenze per scaldabagni</b>	<b>Pag. 14</b>
<b>Sonde di temperatura</b>	<b>Pag. 15</b>
<b>Anodi al magnesio</b>	<b>Pag. 15</b>
<b>Elettrovalvole e valvole gas</b>	<b>Pag. 16</b>
<b>Piloti e accenditori</b>	<b>Pag. 18</b>
<b>Termocoppie e candelette</b>	<b>Pag. 19</b>
<b>Estrattori fumi e pressostati per caldaie</b>	<b>Pag. 20</b>
<b>Tubi e Accessori per fumistica</b>	<b>Pag. 21</b>
<b>Tappi e prelievi fumi</b>	<b>Pag. 22</b>
<b>Vetrini per caldaia</b>	<b>Pag. 22</b>
<b>Mantelli copricaldaia</b>	<b>Pag. 22</b>
<b>Pompe scarico condensa e neutralizzatori</b>	<b>Pag. 23</b>
<b>Tubi raccordo camino in acciaio inox</b>	<b>Pag. 24</b>
<b>Valvole flussostatiche</b>	<b>Pag. 25</b>
<b>Flussostati e pressostati acqua</b>	<b>Pag. 25</b>
<b>Circolatori per caldaie</b>	<b>Pag. 26</b>
<b>Cartucce e motori per valvole 3 vie caldaia</b>	<b>Pag. 26</b>
<b>Valvole deviatrici</b>	<b>Pag. 27</b>
<b>Vasi d'espansione</b>	<b>Pag. 28</b>
<b>Minicompressore gonfiavasi</b>	<b>Pag. 28</b>
<b>Valvole di sicurezza</b>	<b>Pag. 29</b>
<b>Valvole di sfiato aria</b>	<b>Pag. 29</b>
<b>Rubinetti di carico e scarico</b>	<b>Pag. 30</b>
<b>Scambiatori a piastre</b>	<b>Pag. 31</b>
<b>Termometri, manometri e termoidrometri</b>	<b>Pag. 32</b>
<b>Termostati a capillare e a microcontatto</b>	<b>Pag. 33</b>
<b>Membrane per caldaie e scaldabagni</b>	<b>Pag. 34</b>
<b>Prodotti pulizia caldaie</b>	<b>Pag. 35</b>
<b>Guarnizioni, sigillanti e lubrificanti</b>	<b>Pag. 36</b>



## **RICAMBI SPECIFICI PER CALDAIE MURALI A GAS**

<b>RIELLO/BERETTA</b>	<b>Pag. 3</b>
<b>HSD - HERMANN/SAUNIER DUVAL</b>	<b>Pag. 4</b>
<b>IMMERGAS</b>	<b>Pag. 5</b>
<b>ARISTON/MTS/RADI/SIMAT</b>	<b>Pag. 6</b>
<b>CHAFFOTEAUX et MAURY</b>	<b>Pag. 6</b>
<b>OCEAN/BAXI/WESTEN</b>	<b>Pag. 7</b>
<b>UNICAL</b>	<b>Pag. 8</b>
<b>RHOSS</b>	<b>Pag. 8</b>
<b>SILE</b>	<b>Pag. 9</b>
<b>FONDITAL/NOVA FLORIDA</b>	<b>Pag. 9</b>
<b>FERROLI/FER</b>	<b>Pag. 10</b>
<b>VAILLANT</b>	<b>Pag. 11</b>

**Su richiesta sono disponibili tutti i ricambi originali per:**



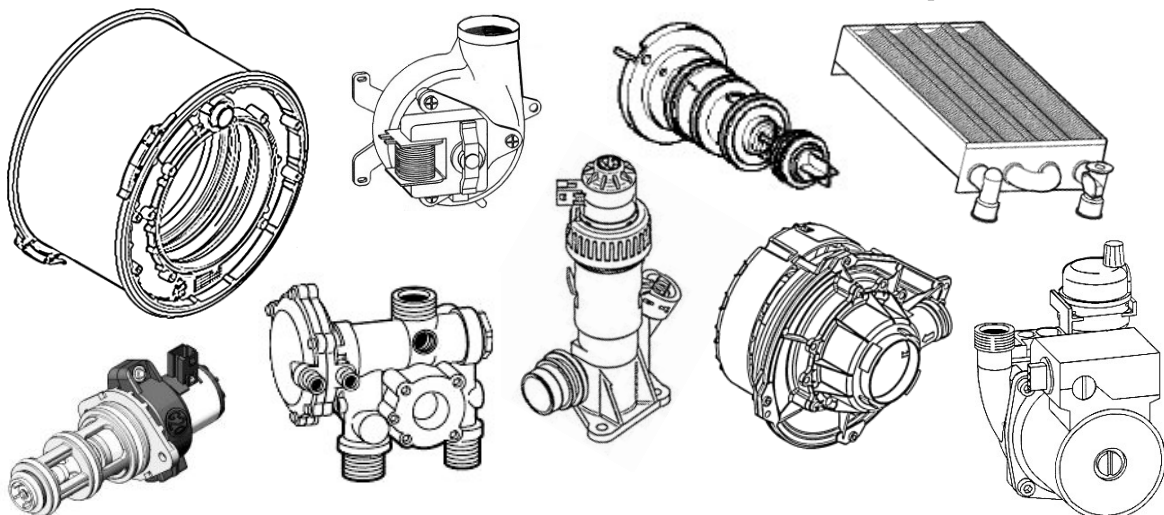







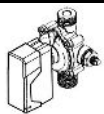
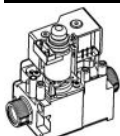

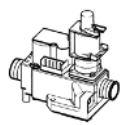
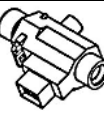
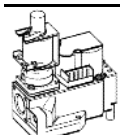
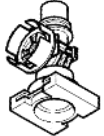
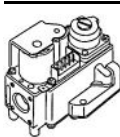
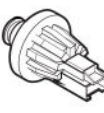

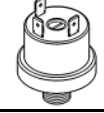

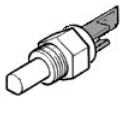
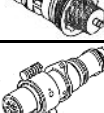

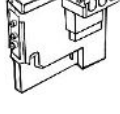

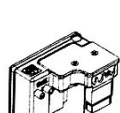
**IMMERGAS - ARISTON/MTS - FONDITAL/NOVA FLORIDA - BERETTA - HERMANN - UNICAL  
CHAFFOTEAUX et MAURY - OCEAN/BAXI**

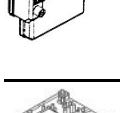
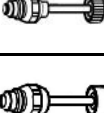
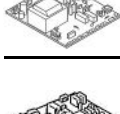

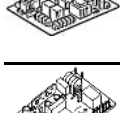









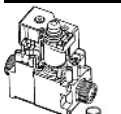

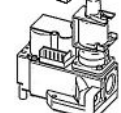
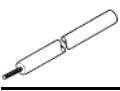

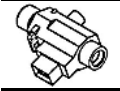
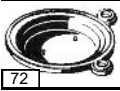

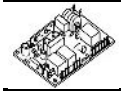
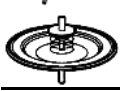

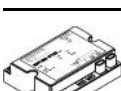
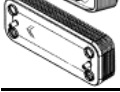

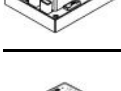





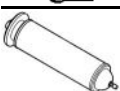

**RIELLO/BERETTA - Su richiesta disponibili tutti i ricambi originali**

			EURO				EURO
	TP022	Flussostato magnetico <b>Bitron</b> attacchi 1/2" M	24,00		CE007	Estrattore fumi 250/2C-RA Imbocco quadro 52x60mm Ventola Ø97 - 24KW	70,00
	CR005	Rubinetto di caricamento <b>Beretta Idra/Exclusive, Riello2000</b>	16,00		CE008	Estrattore fumi 250/2C-RA Imbocco quadro 52x60mm Ventola Ø108 - 28KW	72,00
	CR015	Premistoppa <b>Beretta Exclusive/Meteo</b>	5,00		GP016	Pressostato fumi Huba Control 1,05/0,9 mbar	30,00
	CO011	Premistoppa <b>Beretta, Riello</b>	5,00	<b>EURO</b>			
	CR018	Raccordo distanziatore <b>Riello Benefit/Residence</b>	9,00		CI005	Microinterruttore 3 fili Universale	9,00
	CR020	Cartuccia 3vie <b>Beretta Mynute, Exclusive Riello Residence, Family</b>	46,00		CR009	Staffa microinterruttore <b>Beretta/Riello</b>	5,00
	GR710	Membrana - N°3, 55, 67, 71, 75, 76, 75A <b>Vedi Pag.34</b>	5,00		TZ131	Motore/Attuatore ELBI	27,00
	TI006	Termoidrom.bianco 1/4" M Quad.Ø46mm Foro Ø42mm <b>Riello Domus</b>	21,00		TZ133	Motore/Attuatore ELBI <b>Beretta, Riello modelli vari</b>	48,00
	CR012	Scambiatore 14 piastre attacchi a O.R.	65,00		CR010	Sonda temperatura Blu	6,00
	CR019	Scambiatore 16 piastre attacchi a O.R.	64,00		CI001	Sonda temperatura Nera	6,00
	VE110	Vaso espansione lt. 10 Ø387mm x 120 Attacco 1/4" M conico <b>Beretta Idra, Riello2000</b>	69,00		CR016	Sonda temperatura Blu O.R.	12,00
	VE118	Vaso espansione lt. 8 Ø392mm x 75 1/2" M + staffa <b>Beretta Superexclusive, Riello Nuova Benessere</b>	69,00		CR017	Sonda temperatura a contatto Honeywell T7335	18,00
	VE114	Vaso espansione lt. 8 Ø416mm x 75 1/4" M + staffa <b>Beretta Idra Exclusive, Riello Benefit</b>	84,00		RA112	Apparecchiatura Brahma SM191.1 - <b>Riello2000, Beretta Idra Ionizzate</b>	145,00
	CR008	Valvola sicurezza 3 bar Attacco O.R. <b>Beretta/Riello</b>	11,00		RA117	Apparecchiatura Brahma CM391.2 <b>Basamento stagna</b>	151,00
<b>Interassi tiranti scambiatori attacchi a O.R. a Pag.31</b>					RA807	Scheda Honeywell S4565CF/1045 (ex 1052) <b>Riello a basamento</b>	293,00
	GR012	Valvola gas Honeywell VK4105/A-1027 (Ex 1050)	223,00		RA808	Scheda Honeywell S4565AF/1007 (ex 1064) <b>Riello a basamento IN ESAURIMENTO</b>	234,00
	GR013	Valvola gas Honeywell VK4105/C-1009 (Ex 1025)	210,00		RA600	Scheda SIT 537-002 ABC (ex 507-002) <b>Beretta Superexclusive, Riello Benessere</b>	280,00
	GR150	Valvola gas Sit SIGMA 845.070 Attacchi 3/4" M	120,00				
	GR172	Valvola gas Sit SIGMA 848.160 - 3/4" M <b>Modelli a condensazione</b>	226,00				

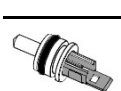
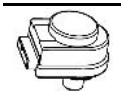









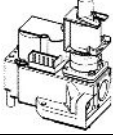
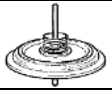
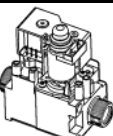
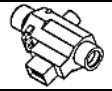
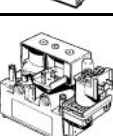
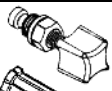

**HSD - Hermann/Saunier Duval - Su richiesta disponibili tutti i ricambi originali**

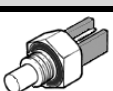
EURO				EURO			
	TP005	Flussostato <b>Giannoni SF11</b> a membrana 1/2" M <b>Modelli Laser</b>	75,00		GR171	Valvola gas SIT SIGMA 848.107 <b>Attacchi filettati 3/4" M</b> <b>Modelli a condensazione</b>	186,00
	CH007	Valvola 3 vie Giannoni <b>Micra, Supermicra e Spaziotekno</b>	178,00		GR024	Valvola gas Honeywell VK4105/M-2105 con Modureg <b>Filetti 3/4" M</b>	335,00
	TP022	Flussostato magnetico <b>Bitron</b> Attacchi 1/2" M	24,00		GR015	Valvola gas Honeywell VK4105/M-2048 Con Modureg <b>Attacchi filettati 1/2" F</b>	323,00
	CV019	Flussostato rotativo <b>Isofast E-P, Themafast, Isomax, Opalia</b>	33,00		GR017	Valvola gas Honeywell VK4105/A-1035 <b>Attacchi filettati 1/2" F</b>	174,00
	CV018	Trasduttore di pressione <b>Spazio4, Micra4, Combitek Themafast condens Semiatek condens</b>	21,00		CH001	Estrattore fumi EBM Imbocco Ø56mm fori venturi G2K097 <b>RO</b> Ventola Ø97 Adattabile <b>Laser, Master, Micra, Spazio</b>	100,00
	TP051	Pressostato di sicurezza mancanza acqua 1/4" M <b>Per modelli senza carico Automatico (Serie Spazio)</b>	18,00	<b>EURO</b>			
	TZ107	Servocomando Honeywell VC6612 - 230V per 3 vie <b>Micro e morsetti Molex</b>	109,00		CR010	Sonda temperatura Blu	6,00
	TZ104	Otturatore di ricambio per valvola VC6012/6612	53,00		CM005	Sonda temperatura Rossa	6,00
	CV020	Cartuccia 3 vie motorizzata <b>Adattabile Thera3, Thesi3, Micra3</b>	59,00		CO010	Sonda temperatura Bianca	6,00
	CH011	Scambiatore 14 piastre Attacchi filettati <b>Micra, Micrapiù, Spaziotekno</b>	83,00		RA809	Scheda Honeywell S4565CD/1039 ( <b>Ex 1021</b> ) <b>Eura, Spazio 0/1</b>	245,00
	CF005	Attacchi filettati 14 piastre 1/2 - 3/4" M <b>Adattabile Spazio plus</b>	60,00		RA814	Scheda Honeywell S4565DD/1045 <b>Spazio 2/3</b> <b>IN ESAURIMENTO</b>	154,00
	VE521	Rubinetto di caricamento L=37mm	10,00		RA602	Scheda Sit 537-301 ABC ( <b>ex 507-301</b> ) <b>Habitat, Spazio Tekno Micra</b>	272,00
	VE529	Rubinetto di carico 75 mm	11,00		RA611	Scheda Sit 579-604 DBC ( <b>ex 577.604, ex 577.603</b> ) <b>Modelli a condensazione</b>	325,00
	CI006	Rubinetto di caricamento L=104mm	11,00		RA222	SM07407 Scheda modulazione <b>Micra2 (fino al 2009)</b>	240,00
	TI006	Termoidrometro bianco 1/4" M Quadrante Ø46mm Foro Ø42mm	21,00		RA223	SM07414 Scheda modulazione con display <b>Thesi, Thesi condensing</b>	303,00
	CH003	Elettrovalvola caricamento CEME 1/4" M x 1/2" M <b>Serie Spazio</b>	40,00		RA226	Bertelli FT14 Scheda accensione <b>Adattabile Laser 24-29 E</b>	149,00

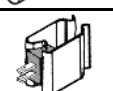

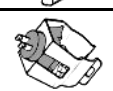

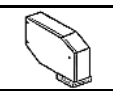
<b>IMMERGAS - Su richiesta disponibili tutti i ricambi originali</b>							
			<b>EURO</b>				<b>EURO</b>
	CI006	Rubinetto di caricamento L=104mm - <b>Extra</b>	11,00		GR151	Valvola gas SIT Sigma 845.063 (Ex 109) - 3/4" M <b>Vari modelli</b>	120,00
	CI013	Rubinetto di caricamento <b>Eolo, Zeus, Supernike, Nike, Supereolo</b>	17,00		GR023	Valvola gas Honeywell VK4105/M-2055 <b>Nuova Avio, Zeus Iono, Vip</b>	370,00
	RS104	Anodo al magnesio Ø16 x L=600mm Filetto 4ma	15,00		GP010	Pressostato fumi Huba Control Reg.fissa 0,47/0,35mbar	30,00
	CI008	Termoidrometro Bianco Foro Ø40mm Attacco 1/4" M	21,00				
	TP022	Flussostato magnetico <b>Bitron</b> attacchi 1/2" M	24,00				
	GR710	Membrana - <b>N°70, 72, 82</b> <b>Vedi Pag.34</b>	5,00				
	CI002	Valvola 3 vie Giannoni <b>Mini</b>	178,00		RA651	Scheda accensione Bertelli & P. FM31 <b>(Sostituisce anche FM19)</b>	160,00
	CI010	Kit membrana Giannoni <b>Mini ed Extra</b>	14,00		RA140	Apparecchiatura Brahma CM32	118,00
	CI007	Scambiatore 13 piastre <b>Nike, Eolo Mini</b>	84,00		RA138	Apparecchiatura Brahma SM11	112,00
	CI015	Scambiatore 14 piastre <b>Eolo Mini kw, Nike Mini kw Eolo Extra kw</b>	50,00		RA146	Apparecchiatura Brahma CM31	112,00
	VE530	Testina di ricambio valvola sicurezza 3 bar	8,00		RA139	Apparecchiatura Brahma CM11	103,00
	VE531	Testina di ricambio valvola sicurezza 8 bar	9,00		RA144	Apparecchiatura Brahma CM31/F	114,00
	VE524	Valvola sicurezza 3 bar <b>Attacco O.R.</b>	10,00		RA137	Apparecchiatura Brahma CM11/F	112,00
	VE480	Valvola sfiato Caleffi plastica Innesto rapido pompe Wilo e Grundfos	10,00		RA159	Apparecchiatura Brahma CM11/O	114,00
	VE116	Vaso espansione lt.8 3/8" M 515mm x 200mm x 110mm	67,00		RA160	Apparecchiatura Brahma CM11F/O <b>Victrix</b>	118,00
	VE006	Vaso idrico lt.2 - 1/2" M Ø120 x 235mm <b>Hercules, Zeus</b>	41,00		CI004	Microinterruttore con guscio <b>Supernike, Supereolo, Eolo, Nike</b>	11,00
	VE012	Vaso idrico Style lt.4 - 1/2" M Ø80 x 655mm <b>Per bollitori lt.60/120</b>	102,00		CI005	Microinterruttore a leva 3 fili - Universale	9,00
					CI014	Microinterruttore a forchetta <b>Modelli Mini</b>	20,00
					CI001	Sonda temperatura Nera	6,00
					CI003	Sonda temperatura rossa Corpo ottone (ex grigia)	6,00
					CM005	Sonda temperatura Rossa	6,00
					CO010	Sonda temperatura Bianca	6,00
					CI009	Sonda temperatura Rossa Innesto a O.R. - <b>Modelli KW</b>	12,00
					TZ131	Motore/attuatore <b>ELBI</b>	27,00
	CE004	Estrattore fumi 200/2C-RA Imbocco Ø58mm Ventola Ø108 - <b>Vari modelli</b>	124,00		TZ133	Motore/Attuatore <b>ELBI</b> <b>Modelli vari</b>	48,00
	CE006	Estrattore fumi 250/2C-RA Imbocco 60x60mm <b>Supereolo, Nuova Zeus</b>	120,00				

**ARISTON/SIMAT/RADI/MTS - Su richiesta disponibili tutti i ricambi originali**

EURO				EURO			
	TP204	Valvola 3 vie Giannoni Dx <b>Meta, Dia, RX, SP</b>	178,00		CE003	Estrattore fumi LN200/2C-RO Ventola Ø108, Imbocco Ø58 <b>Vari modelli</b>	169,00
	CM008	Cartuccia 3vie <b>Genus Premium, Clas, Egis</b>	20,00		GR027	Valvola gas Honeywell VK4105/M-2014 ex 2097 <b>Dia, Genus, Codex</b>	215,00
	TP004	Membrana per 3vie <b>Meta, Dia, RX, SP</b>	14,00		GR150	Valvola gas Sit SIGMA 845.070 - 3/4" M <b>New Genus, New Codex, Microgenus</b>	120,00
	TP022	Flussostato magnetico <b>Bitron Attacchi 1/2" M One, Microtec, Next, Est</b>	24,00		GR106	Valvola gas Sit NOVA 837.013 Tandem <b>Genus, Codex, Capax</b>	386,00
	CR005	Rubinetto di caricamento <b>Meta, Dia, Genus</b>	16,00	<b>EURO</b>			
	CO006	Rubinetto di caricamento <b>Egis, Genus premium, Clas</b>	9,00		CM003	Sonda NTC Verde	7,00
	GR710	Membrana - N° 55, 86 <b>Vedi Pag.34</b>	5,00		CR017	Sonda Honeywell a contatto T7335 <b>Uno, Trend</b>	18,00
	CM009	Valvola di sicurezza 3bar in composito - Innesto O.R. Uscita 3/8" M	14,00		CM012	Sonda a contatto <b>Genus, Microgenus, Clas, Rio</b>	7,00
	CM002	Scambiatore 14 piastre Attacchi O.R. - <b>Codex, Es, Genus, Microgenus</b>	61,00		CM006	Microinterruttore incassato <b>Ex, Sp, Re, Arx</b>	27,00
	CM013	Scambiatore 16 piastre Attacchi O.R. - <b>Codex, Es, Genus, Microgenus</b>	63,00		TZ131	Motore/attuatore <b>ELBI Genus, Genus incasso, Es, Codex, Clas, Egis</b>	27,00
	CM001	Scambiatore 14 piastre Attacchi O.R. - <b>Clas, Egis, Genus Premium</b>	46,00	<b>Interassi tiranti scambiatori attacchi a O.R. a Pag.31</b>			
	CN002	Scambiatore 14 piastre Attacchi O.R. <b>Trend, Uno</b>	58,00				

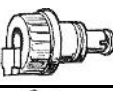
**CHAFFOTEAUX - Su richiesta disponibili tutti i ricambi originali**

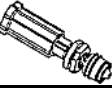















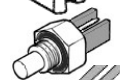

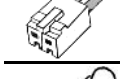

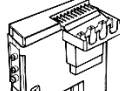

EURO				EURO			
	GR710	Membrana - N° 25, 43, 51, 58, 59, 65 <b>Vedi Pag.34</b>	5,00		CC023	Flussostato SIRAM <b>Adattabile Calidra/Nectra</b>	63,00
	CM009	Valvola di sicurezza 3bar in composito - Innesto O.R. Uscita 1/2" M	14,00		CC024	Motore valvola 3 vie <b>Adattabile Nectra</b>	65,00
	CO006	Rubinetto di caricamento <b>Alixia, Pigma, Talia, Urbia</b>	9,00		CM008	Cartuccia 3vie <b>Alixia, Pigma, Talia, Urbia</b>	20,00
	CO007	Scambiatore sanitario 14 piastre <b>Adattabile Nectra, Elexia, MC, Centora</b>	60,00	<b>EURO</b>			
	CN002	Scambiatore 14 piastre O.R. <b>Adattabile Elexia confort, Compy, Calidra I° serie</b>	58,00		CC015	Sonda temperatura nuovo tipo - Attacco rapido OR <b>Calidra, Nectra, Maya</b>	11,00
	CM001	Scambiatore 14 piastre Attacchi O.R. - <b>Niagara C, Alixia, Pigma, Urbia, Thalia</b>	46,00		CM012	Sonda a contatto <b>Mira, Niagara, Talia, Urbia, Centora</b>	7,00
<b>Interassi tiranti scambiatori attacchi a O.R. a Pag.31</b>							

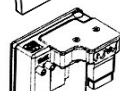

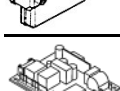

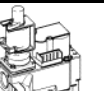

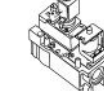
**UNICAL - Su richiesta disponibili tutti i ricambi originali**

			EURO				EURO
	VE530	Testina di ricambio valvola sicurezza 3 bar	8,00		CE031	Estrattore fumi Ø97 E15-98/GR-RO <b>Dua 24Kw</b>	120,00
	VE531	Testina di ricambio valvola sicurezza 8 bar	9,00		CE033	Estrattore fumi Ø108 E15-108/GR-RO <b>Dua 28 Kw</b>	158,00
	VE521	Rubinetto di caricamento	10,00	<b>EURO</b>			
	TP050	Pressostato sicurezza mancanza acqua - 1/8"M	19,00		CR017	Sonda temperatura a contatto Honeywell T7335D	18,00
	CU003	Gruppo acqua a membrana Attacchi 1/4"M <b>Dua CT prima serie</b>	43,00		CU001	Sonda temperatura Verde <b>Con CB006 sostituisce T7335C2008 in ottone</b>	8,00
	VE113	Vaso espansione lt.10 Ø387mm - 3/4"M centrale <b>Gea Basamento</b>	69,00		CB006	Connettore con cavetti per sonda NTC	5,00
	VE115	Vaso espansione lt.8 Ø387mm - 3/8"M <b>Murali istantanee CT</b>	66,00		CU002	Microinterruttore filettato per gruppo acqua <b>Dua CT</b>	20,00
	TP022	Flussostato magnetico Bitron attacchi 1/2"M <b>Dua, Iven, Enter, Alkon, Eve</b>	24,00		RA808	Scheda Honeywell S4565AF/1007 <b>Dua CT IN ESAURIMENTO</b>	234,00
	CH003	Elettrovalvola caricamento CEME - 1/4"M x 1/2"M <b>Enter, Ipsen Entrofuori</b>	40,00		RA809	Scheda Honeywell S4565CD/1039 <b>Cutter</b>	245,00
	CI015	Scambiatore 14 piastre <b>Alkon Ink</b>	50,00		RA602	Scheda SIT 537-301 ABC	272,00
<b>EURO</b>					RA821	Scheda Honeywell S4561A/1007 Accensione <b>DUA, GEA</b>	194,00
	GR003	Valvola gas Honeywell VK4105/N-2013	270,00		RA201	Scheda W4115B/1218 <b>Cutter BSE, Clipper,DUA BTFS,Dua Cargo IN ESAURIMENTO</b>	395,00
	GR021	Valvola gas Honeywell VR4605/NA-2031	240,00		RA202	Scheda W4115B/1192 <b>DUA CTFS, Cutter CSE, RSE IN ESAURIMENTO</b>	213,00

**RHOSS**

			EURO				EURO
	TZ015	Mut SF20/E - 3/4"M Valvola 3 vie motorizzata <b>Serie Spazio con bollitore</b>	138,00		CE034	Estrattore FIME GR800-RO Ventola RL97 con prelievi Imbocco Ø56mm - <b>Spazio</b>	75,00
	TP010	Mut SFS1 - 1/4"M Flussostato differenziale Micro SPDT <b>Spazio bollitore</b>	85,00		CE003	Estrattore LN200/2C-RO Imbocco Ø58mm Ventola Ø108	169,00
	GR710	Membrana N° 55, 86 <b>Vedi Pag.34</b>	5,00	<b>EURO</b>			
	CR012	Scambiatore sanitario 14P Attacchi OR <b>Serie Spazio istantanea</b>	65,00		RA651	Scheda accensione FM31 Bertelli & P. (Sost.FM37) <b>Serie Aurora</b>	160,00
	CM002	Scambiatore sanitario 14P Attacchi OR <b>Serie Aurora istantanea</b>	61,00		TZ131	Motore/attuatore ELBI 230V <b>Serie Aurora con bollitore</b>	27,00
<b>Interassi tiranti scambiatori attacchi a O.R. a Pag.31</b>							





<b>SILE - Su richiesta disponibili ricambi originali</b>				<b>EURO</b>	
	TP021	Flussometro 1/2" M Caleffi 316 <b>Superapida</b>	33,00		TZ131 Motore/attuatore <b>ELBI Mod. Condensa</b> 27,00
	TP018	Flussostato 3/4" M <b>Per caldaie murali a condensazione</b>	78,00		RA245 Schedone Brahma 16020900 - <b>Istantanee</b> 369,00
	TP050	Pressostato sicurezza mancanza acqua - 1/8" M	19,00		RA246 Schedone Brahma 16020910 - <b>Con bollitore</b> 380,00
	TP203	Valvola Giannoni 3vie <b>Turbinox</b>	178,00		RA244 Scheda funzione Bertelli LC06N 252,00
<b>EURO</b>					RA247 Scheda funzione Bertelli MLC02.01 246,00
	GR027	Valvola gas Honeywell VK4105/M-2014 <b>Superapida Turbinox</b>	215,00		RA248 Scheda Bertelli DIMS16-S01 252,00
	GR026	VK4105/M-5017 moduleg	233,00		RA249 Scheda Bertelli DIMS16-S02 268,00
	CE002	Estrattore fumi LN200 Con venturi <b>Modelli Bi-TBi</b>	169,00		RA651 Scheda accensione FM31 Bertelli & P. ( <b>Sost.FM25</b> ) <b>Turbinox - SA Superapida</b> 160,00
	CE015	Estrattore fumi con venturi e staffa - <b>AACO ET22 SUPERAPIDA 23</b>	152,00		CI003 Sonda temperatura rossa Corpo ottone (ex grigia) 6,00
	CE016	Estrattore fumi con venturi e staffa - <b>AACO ET25 SUPERAPIDA 31</b>	156,00		

**FONDITAL/NOVA FLORIDA - Su richiesta disponibili tutti i ricambi originali**

<b>EURO</b>				<b>EURO</b>	
	VE528	Rubinetto di carico 60 mm <b>Tahiti, Pictor</b>	11,00		GR150 Valvola gas Sit SIGMA 845.070 Attacchi 3/4" M <b>Panarea, Tahiti, Pictor, Delfis</b> 120,00
	TP018	Flussostato 3/4" M <b>Per caldaie murali a condensazione</b>	78,00		TZ131 Motore/Attuatore ELBI 27,00
	TP050	Pressostato sicurezza mancanza acqua 1/8" M	19,00		
	CN002	Scambiatore 14 piastre attacchi O.R. <b>Pictor, Formentera</b>	58,00		
	VE524	Valvola sicurezza 3 bar <b>Attacco O.R.</b>	10,00		GR906 Valvola gas 25M42M <b>Fondital New Gazelle, Windor Classic, Techno</b> 138,00
	TP022	Flussostato magnetico <b>Bitron</b> attacchi 1/2" M	24,00		RA707 Quadro elettrico <b>Fondital Techno Windor classic</b> 260,00
<b>EURO</b>					CN011 Solenoide e bobina bipotenziiale <b>Fondital Gazelle, Windor</b> 75,00
	RS211	Ventola combustione <b>Fondital Gazelle, Windor 2500/4000</b>	201,00		
	GP010	Pressostato fumi Huba Control 0,47/0,35mbar	30,00		

**FERROLI/FER**

			EURO				EURO
	TP009	Flussostato a paletta Caleffi NAV - 1/2\"M	58,00		CE007	Estrattore fumi 250/2C-RA Imbocco 52x60mm Caldaie 24KW	70,00
	TP020	Sensore di portata 1/2\"M Honeywell (Flussometro) C7195A/2001	34,00		CE008	Estrattore fumi 250/2C-RA Imbocco 52x60mm Caldaie 28KW	72,00
	TP024	Flussometro Eltek Attacchi 1/2\"M - Diva Top, Ferdigit, Fersystem	30,00		GP010	Pressostato fumi Huba Control 0,47/0,35mbar	30,00
	TP021	Sensore di portata Caleffi 1/2\"M in ottone (Flussometro)	33,00		CF012	Kit venturi estrattore fumi in plastica	25,00
	TP023	Sensore portata ad angolo 1/2\"M in ottone (Flussometro)	48,00	<b>Interassi tiranti scambiatori attacchi a O.R. a Pag.31</b>			
	CI008	Termoidrometro Bianco Foro Ø40mm Attacco 1/4\"M	21,00	<b>EURO</b>			
	CF005	Scambiatore a piastre attacchi filettati 1/2 - 3/4\" 14 piastre	60,00		RA128	Apparecchiatura Brahma SM191.2	145,00
	CN002	Scambiatore a O.R. 14 piastre Econcept	58,00		RA820	Scheda Honeywell S4561B/1013 (ex 1015) Scheda accensione murali IN ESAURIMENTO	305,00
	CF008	Trasduttore di pressione Attacco filettato 1/4\"M	27,00		RA818	Scheda Honeywell S4565DM/1003 (ex 1060) Domina Insert, Igloo IN ESAURIMENTO	202,00
	CF009	Trasduttore di pressione Attacco O.R.	27,00		RA819	Scheda Honeywell S4564BF/1006 Pegasus F3	183,00
	CF010	Gruppo di caricamento Domina, Igloo, Domitop DGT	29,00		RA232	Scheda modulazione MF03F.1 (S4562DM1022) Domina, Domina Plus	215,00
	CF011	Gruppo di caricamento Domicompact, Ferella Zip	33,00		RA233	Scheda modulazione MF08FA - SM16501 Domicompact, Ferella Zip	320,00
	CF014	Gruppo di caricamento Domitop, Ferella Gold	26,00		RA234	Scheda modulazione DBM01A - SM16503 Domiproject, Domininsert	368,00
	CF013	Rubinetto di caricamento 1/2\"M - 3/4\"M	58,00		CF001	Sonda temperatura Verde PTC	8,00
	VE480	Valvola sfiato Caleffi plastica innesto rapido pompe Wilo e Grundfos	10,00		CF002	Sonda temperatura Colore neutro Tipo Domina	7,00
	CF006	Motore per valvola 3vie Motorizzata Fersystem, Diva Top, Ferdigit, Econcept	84,00		CF003	Sonda a contatto a bracciale Ø15mm	7,00
<b>EURO</b>					CR017	Sonda temperatura a contatto Honeywell T7335	18,00
	GR029	Valvola gas Honeywell VK4105/G-1070 Attacco 1/2\"M + flangia	198,00		CF004	Sonda temperatura a Contatto 4 fili Sonda + sicurezza	24,00
	GR801	Termocoppia ASA mm.750 doppio dado	15,00				







**VAILLANT**

			EURO
	CV005	Premistoppa VCW	5,00
	CV011	Valvola 3 vie motorizzata per <b>VMW</b>	120,00
	CV021	Valvola 3 vie motorizzata per <b>Ecotec Plus 3-5</b>	106,00
	CV020	Cartuccia 3 vie motorizzata <b>VMW serie CS</b>	59,00
	CV017	Motore per valvola 3vie <b>Ecotec, Turbo/Atmoblock</b>	24,00
	CV003	Rubinetto di carico Filetto 1/4M e innesto a O.R. <b>Ecoblock, VMW Plus 2-3-4, e TurboPlus 2-3-4</b>	18,00
	GR710	Membrana N°15, 66, 84, 85 <b>Vedi Pag.34</b>	5,00
	CV001	Circolatore Wilo RSL15/80 con separatore aria Attacchi 3/4”M <b>Adattabile VCW</b>	148,00
	TZ016	MUT SF25/E - 1”M Valvola 3 vie motorizzata <b>Modelli a basamento</b>	143,00
	CV009	Scambiatore filettato a 14 piastre senza raccordi per <b>VCW</b>	66,00
	CV002	Kit scambiatore sanitario a 14 piastre con raccordi per <b>VCW Tecnoblock (Sostituisce scambiatore sanitario originale in materiale composito)</b>	100,00
	CV007	Raccordo per adattamento scambiatore CV009 a Modelli <b>VMW- VMW/1</b>	8,00
	CV010	Scambiatore 14 piastre a 3 innesti rapidi - <b>L=190mm VMW3-5- Pro Corto</b>	60,00
	CV016	Scambiatore 20 piastre a 3 innesti rapidi - <b>L=190mm VMW3-5- Pro Corto</b>	84,00
	CV012	Scambiatore 14 piastre a 3 innesti rapidi - <b>L=205mm VMW3-5- Plus Lungo</b>	75,00
	CV014	Scambiatore con alette 14P <b>Ecoblok Pro, Ecoblok Plus Turboblok Plus</b>	66,00
	CV015	Scambiatore con alette 20P <b>Ecoblok Pro, Ecoblok Plus Turboblok Plus</b>	82,00

Interassi tiranti scambiatori attacchi a O.R. a Pag.31

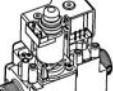
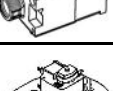
			EURO
	CV006	Termometro quadrato VCW	46,00
	TP020	Sensore portata 1/2”M (Flussometro) Honeywell C7195A/2001 <b>Mag Turbo</b>	34,00
	CV018	Trasduttore di pressione <b>Ecotec, Turboblock, Atmoblock</b>	21,00
	CV019	Flussostato rotativo <b>Nuova Ecoblock, EcoTec, Turbo/Atmoblock</b>	33,00
	CV013	Valvola sicurezza a innesto rapido femmina <b>VMW, VMI</b>	18,00
	VE480	Valvola sfiato Caleffi plastica innesto rapido pompe Wilo e Grundfos	10,00

			EURO
	GR023	Valvola gas Honeywell VK4105/M2055 <b>Intercambiabile VK4115/M2039, 2054 e 2062</b>	370,00
	GR171	Valvola gas SIT SIGMA 848.107 <b>Attacchi filettati 3/4”M Modelli a condensazione</b>	186,00
	CE009	Estrattore LN250/2C-RO Imbocco 52x60mm - 28 kW <b>Adattabile VCW, VMW1</b>	115,00
	GP019	Pressostato fumi Huba Control 1,00/0,72mbar	30,00

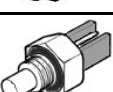
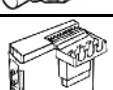
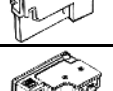
			EURO
	CV004	Sonda temperatura <b>VCW</b>	10,00
	CF001	Sonda NTC verde <b>Basamento</b>	8,00
	RA811	Scheda Honeywell S4565TM/1021B <b>Vaillant MAG20 IN ESAURIMENTO</b>	332,00
	RA611	Scheda Sit 579-604 DBC (ex 577.604, ex 577.603) <b>Per caldaie a condensazione</b>	325,00

**APPARECCHIATURE E SCHEDE ELETTRONICHE****BRAHMA Serie EUROFLAT/MINIPLAT**

<b>EURO</b>				<b>EURO</b>			
	RA151	CE11 - Tw 20" Ts 5" Riarmo automatico <b>Generatori pensili</b>	93,00		RA114	FM11 - Tw 1,5" Ts 10" <b>Sime</b>	112,00
	RA150	CE31 - Tw 30" Ts 10" Riarmo automatico <b>Generatori pensili</b>	119,00		RA149	FM31 - Tw 5" Ts 10" <b>Sime camera stagna</b>	128,00
	RA139	CM11 - Tw 1,5" Ts 10" <b>Ici, Immergas, Bongioanni, Riello</b>	103,00		RA138	SM11 - Tw 1,5" Ts 10" <b>Beretta, Immergas, Bongioanni</b>	112,00
	RA142	CM11 - Tw 30" Ts 10" <b>Accorroni</b>	105,00		RA145	SM11 - Tw 5" Ts 60" <b>Gruppo Imar</b>	113,00
	RA159	CM11/O - Tw 1,5" Ts 10" <b>Immergas</b>	114,00		RA156	TM11 - Tw 1,5" Ts 10" <b>Joannes, Finterm, Arca</b>	99,00
	RA137	CM11/F - Tw 1,5" Ts 10" <b>Immergas</b>	112,00		RA157	TM12 - Tw 1,5" Ts 10" <b>Riello</b>	123,00
	RA160	CM11F/O - Tw 1,5" Ts 10" <b>Immergas</b>	118,00		RA158	TM31 - Tw 1,5" Ts 10" <b>Joannes, Finterm, Arca</b> <b>Sostituisce Bertelli FM11</b>	115,00
	RA144	CM31/F - Tw 1,5" Ts 10" <b>Immergas</b> <b>Intercambiabile CM31/U</b>	114,00		<b>Connettori</b>		
	RA161	CM31/F - Tw 20" Ts 10" <b>Radiatori a gas,</b> <b>tubi radianti</b>	115,00	<b>EURO</b>			
	RA146	CM31 - Tw 1,5" Ts 10" <b>Immergas, Riello, Sile,</b> <b>Joannes</b>	112,00		RA251	Connettore multipoli per BRAHMA CM/SM Varie misure	3,00
	RA143	CM31 - Tw 30" Ts 10" <b>Accorroni</b>	113,00		RA253	Terminale ad aggaffare BRAHMA CM/SM <b>Confezione Pz.10</b>	3,00
	RA140	CM32 - Tw 1,5" Ts 10" <b>Immergas, Gruppo IMAR</b>	118,00	<b>Fusibili - Confezioni Pz.10</b>			
	RA148	CM32 - Tw 30" Ts 10" <b>Accorroni, Apen Group,</b> <b>Riello</b>	123,00	<b>EURO</b>			
	RA141	CM32 - Tw 1,5" Ts 60" <b>Sylber</b>	125,00		FA001	Fusibili 315 mA	4,00
	RA147	CM32/CSP A.R. Tw 5" Ts 30" <b>Gruppo Imar, Sime</b>	162,00		FA002	Fusibili 500 mA	4,00
	RA152	CM32/PR - Tw 30" Ts 10" <b>Robur</b>	100,00		FA003	Fusibili 1 A	4,00
	RA136	DTM31/PR Tw 30" - Ts 10" <b>Robur</b>	133,00		FA004	Fusibili 2 A	4,00
					FA005	Fusibili 3,15 A	4,00
					FA006	Fusibili 4 A	4,00
				<b>Disossidante Spray per contatti</b>			
				<b>EURO</b>			
					SA356	CHEM SP17 ml.400 Solvente per elettronica Elimina lo sporco senza lasciare residui né aggredire i materiali di supporto	30,00

**HONEYWELL serie S45...**

			<b>EURO</b>
	RA803	S4585D/1011 <b>Sylber, Riello IN ESAURIMENTO</b>	182,00
	RA807	S4565CF/1045 <b>(ex 1052, 1078, 1003) Riello basamento, Sime, Savio, Lamborghini</b>	293,00
	RA808	S4565AF/1007 <b>(ex 1064, 1056) Unical, Saunier Duval, Riello Domus IN ESAURIMENTO</b>	234,00
	RA809	S4565CD/1039 - <b>(ex 1021)</b> <b>Unical, Hermann</b>	245,00
	RA814	S4565DD/1045 <b>Hermann Serie Spazio IN ESAURIMENTO</b>	154,00

			<b>EURO</b>
	RA811	S4565TM/1021 - <b>Vaillant MAG20 IN ESAURIMENTO</b>	332,00
	RA825	S4565C/1025/V01 <b>Apen Group</b>	242,00
	RA826	S4565DM/3094 <b>Apen Group IN ESAURIMENTO</b>	335,00
	RA805	S4565A/2019 <b>Radiant, FBR, Blowtherm, Farel</b>	226,00
	RA812	S4565QM/1012 <b>Radiant, FBR, Blowtherm IN ESAURIMENTO</b>	381,00
	RA818	S4565DM/1003 <b>(ex 1060)</b> <b>Fer, Ferroli IN ESAURIMENTO</b>	202,00
	RA819	S4564BF/1006 <b>Fer, Ferroli</b>	183,00

**SIT**

			<b>EURO</b>
	RA600	537-002 ABC <b>(Ex 507)</b> <b>Riello, Beretta</b>	280,00
	RA602	537-301 ABC <b>(ex 507)</b> <b>Unical, Hermann, Sime, Adatt.Comex 537.309</b>	272,00
	RA603	537-401 ABC <b>(Ex 507)</b> <b>Savio, Biasi</b>	350,00
	RA604	537-403 ABC <b>(Ex 507)</b> <b>Fraccaro</b>	325,00
	RA611	579-604 DBC <b>(ex 577.604, ex 577.603)</b> <b>Hermann/Saunier Duval e Vaillant a condensazione</b>	325,00

**HONEYWELL Serie S4561**

			<b>EURO</b>
	RA820	S4561B/1013 <b>(ex 1015)</b> <b>Fer, Ferroli IN ESAURIMENTO</b>	305,00
	RA821	S4561A/1007 <b>Unical</b>	194,00

**BERTELLI & PARTNERS**













			<b>EURO</b>
	RA651	FM31 <b>(Sost.FM19, 25, 37)</b> <b>Immergas, Sile, Rhoss Intercamb.Brahma CM31</b>	160,00
	RA226	FT14 - <b>Adattabile</b> <b>Hermann Laser 24-29 E, Lamborghini Inova</b>	149,00

**BRAHMA Serie EUROBOX**



			<b>EURO</b>
	RA112	SM191.1 - Tw 1,5" Ts 10" <b>Riello, Beretta, Sime, Joannes, Savio, Finterm</b>	145,00
	RA118	CM191.1 - Tw 1,5" Ts 10" <b>Apen Group</b>	129,00
	RA128	SM191.2 - Tw 1,5" Ts 10" <b>Fer, Ferroli, Ctmc, Fais, Pensotti</b>	145,00
	RA131	CM191.2 - Tw 1,5" Ts 10" <b>Sime, Lamborghini, Riello Pensotti, Joannes, Ctmc</b>	130,00
	RA134	SM192.2 - Tw 1,5" Ts 10" <b>Apen Group, Chaffoteaux</b>	145,00
	RA133	CM191.3 - Tw 1,5" Ts 10" <b>Unical</b>	123,00

			<b>EURO</b>
	RA117	CM391.2 - Tw 1,5" Ts 10" <b>Riello, Baltur, Ctmc, Sime, Pensotti</b>	151,00
	RA111	SM152.2 - Tw 30" Ts 10" Può sostituire IONO700/800 Con modifiche al cablaggio <b>Robur pensili</b>	146,00
	RA153	CM381.4 - Tw 30" Ts 5" <b>Ctmc</b>	153,00
	RA154	CE191.4 - Tw 30" Ts 10" Riarmo automatico Tubi radianti, <b>Fraccaro</b>	112,00
	RA155	CE391.4 - Tw 30" Ts 10" Riarmo automatico Tubi radianti, <b>Fraccaro</b>	133,00

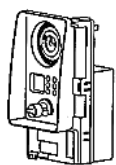

**SCHEDE DI MODULAZIONE**

			EURO				EURO
	RA222	SM07407 <b>Hermann Micra2 (fino al 2009)</b>	240,00		RA211	Scheda SM11447 <b>BAXI Luna 240-310</b>	331,00
	RA223	SM07414 con display <b>Hermann Thesi, Thesi condensing</b>	303,00				
	RA232	MF03F.1 (S4562DM1022) <b>Ferrolì Domina, Domina Plus</b>	215,00		RA245	Schedone Brahma 16020900 <b>Sile</b>	369,00
	RA233	MF08FA - SM16501 <b>Ferrolì Domicompact, Ferella Zip</b>	320,00		RA246	Schedone Brahma 16020910 <b>Sile con bollitore</b>	380,00
	RA234	DBM01A - SM16503 <b>Ferrolì Domiproject, Dominsert</b>	368,00		RA244	Scheda funzione Bertelli LC06N <b>Sile</b>	252,00
	RA201	W4115B/1218 <b>Unical DUA BTFS, Dua Cargo, Clipper, Cutter BSE IN ESAURIMENTO</b>	395,00		RA247	Scheda funzione Bertelli MLC02.01 <b>Sile</b>	246,00
	RA202	W4115B/1192 <b>Unical DUA CTFS, Cutter CSE, RSE IN ESAURIMENTO</b>	213,00		RA248	Schedone Bertelli DIMS16-S01 <b>Sile</b>	252,00
					RA249	Schedone Bertelli DIMS16-S02 <b>Sile</b>	268,00

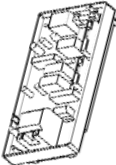
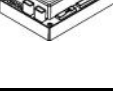
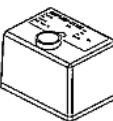
**APPARECCHIATURE x Radiatori a gas**









			EURO				EURO
	RA707	Quadro elettrico <b>Fondital Techno Windor classic</b>	260,00		RA152	CM32/PR - Tw 30" Ts 10" <b>Robur</b>	100,00
	RA705	Quadro elettrico <b>Robur Supercromo</b>	168,00		RA136	DTM31/PR Tw 30" - Ts 10" <b>Robur</b>	133,00
					RA111	SM152.2 - Tw 30" Ts 10" Può sostituire <b>IONO700-800</b> Con modifiche al cablaggio <b>Robur pensili</b>	146,00

**RESISTENZE PER SCALDABAGNI ELETTRICI**

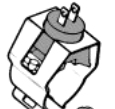

			EURO				EURO
	RS002	Resistenza 1000W Filetto 1"1/4, cm.30	30,00		RS004	Resistenza 2000W Filetto 1"1/4, cm.40	32,00
	RS003	Resistenza 1500W Filetto 1"1/4, cm.30	30,00		RS001	Termostato regolabile MGR cm.27 regolabile 10/80°C	16,00

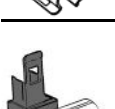

**SONDE DI TEMPERATURA**

			EURO				EURO
	CB003	Verde <b>Biklim, Roca</b>	7,00		CM005	Rossa <b>Beretta, Riello, Hermann, Merloni, Baltur, Immergas</b>	6,00
	CT001	Verde <b>Finterm, Euroterm, ICI, Joannes</b>	7,00		CO010	Bianca <b>Baxi, Hermann, Immergas</b>	6,00
	CU001	Verde <b>NTC 10K Unical</b>	8,00		CI003	Rossa e ottone (ex grigia) <b>Immergas, Sime, Sile</b>	6,00
	CF001	Verde <b>PTC 1K Fer, Ferroli</b>	8,00		CR010	Blu <b>Riello, Beretta, Ocean, Radiant, Hermann</b>	6,00
	CM003	Verde <b>Merloni, Ariston, Simat, Radi, Ecoflam</b>	7,00		CI001	Nera <b>Riello, Beretta, Immergas, Ocean, Radiant, Lamborghini</b>	6,00
	CS001	Verde <b>Savio, Roca, Biasi, Idealclima</b>	7,00		CR016	Blu O.R. <b>Riello, Beretta, Baxi, Sime Murelle</b>	12,00
	CF002	Neutra <b>Ferroli Domina</b>	7,00	CI009	Rossa O.R. <b>Immergas</b>	12,00	
	CR017	Rossa contatto Honeywell T7335D1008 ( <b>Sost.1016</b> ) <b>Beretta, Unical, Ferroli, MTS</b>	18,00	CS002	Nera O.R. <b>Savio</b>	6,00	
	CM012	A contatto clip Ø18mm <b>Ferroli, MTS, Chaffoteaux</b>	7,00	CC015	Ottone O.R. <b>Chaffoteaux nuovi modelli</b>	11,00	
	CF003	A contatto clip Ø15mm <b>Ferroli</b>	7,00	CV004	Speciale <b>Vaillant VCW</b>	10,00	
	CF004	Sonda temperatura a contatto 4 fili, <b>Lamborghini, Ferroli, Joannes</b>	24,00	TY250	Brahma ST07 a immersione <b>NTC 10K - Cavo mt.1,75 Per bollitori</b>	17,00	
	CN003	Nordgas a contatto clip Ø14mm - <b>Immergas, Sile Radiant, Fondital</b>	8,00	CB006	Connettore con cavetti per sonda NTC <b>(Specificare tipo di sonda)</b>	5,00	
	CN004	Nordgas a contatto clip Ø18mm - <b>Immergas, Sile Radiant, Fondital</b>	8,00				

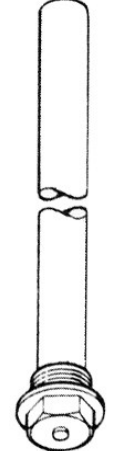
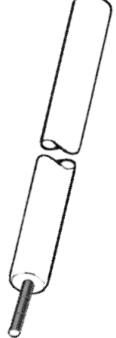
**ANODI AL MAGNESIO**

			EURO				EURO
	RS100	Anodo Ø 21 x L=300 mm Tappo 3/4" M e filetto M8	18,00		RS104	Anodo Ø16 x L=600 mm Filetto 4ma <b>Adattabile Immergas</b>	15,00
	RS101	Anodo Ø 21 x L=400 mm Tappo 3/4" M e filetto M8	21,00				
	RS102	Anodo Ø 26 x L=320 mm Tappo 1" M	24,00				
	RS105	Anodo Ø 32 x L=320 mm Tappo 1" 1/4 M	54,00				
					RS103	Tappo 1/2" M filetto 4ma Per anodo RS104	4,00





## ELETTROVALVOLE GAS

### Honeywell VK C.V.I.

			EURO
	GR018	VK4100/C-1000 con uscita pilota <b>Beretta, Sylber, Unical</b>	155,00
	GR012	VK4105/A-1027 (Ex 1050) <b>Beretta, Riello, Radiant</b> Adattabile <b>Sime, Immergas, Hermann</b>	223,00
	GR017	VK4105/A-1035 - 1/2" F Adattabile <b>VK4105M-2048 Radiant, Hermann, Blowtherm</b>	174,00
	GR013	VK4105/C-1009 (Ex 1025) <b>Immergas, Kalard, Sylber</b> Adattabile <b>Unical, Ici</b>	210,00
	GR029	VK4105/G-1070 1 attacco 1/2" M <b>Fer, Ferroli</b>	198,00
	GR030	VK4105/G-1112 Attacchi 1/2" M <b>Radiant, FBR, Blowtherm</b>	163,00
	GR028	VK4105/G-1005 <b>Beretta, Radiant, Riello, Unical, Blowtherm</b>	327,00
	GR031	VK4105/G-1138 Attacchi 3/4" M - <b>Blowtherm Radiant, FBR, Apen Group</b>	198,00

			EURO
	GR024	VK4105/M-2105 Modureg 17 Vcc - Filetti 3/4" M <b>Hermann</b>	335,00
	GR023	VK4105/M-2055 Modureg 17Vcc - <b>Immergas, Sime, Joannes</b> Intercamb. <b>VK4115/M-2039, 2054 e 2062 per Vaillant</b>	370,00
	GR015	VK4105/M-2048 Modureg Filetti 1/2" F <b>Hermann</b>	323,00
	GR026	VK4105/M-5017 Modureg <b>Sime, Sile</b>	233,00
	GR027	VK4105/M-2014 Modureg (Ex 2097) <b>Sile, MTS</b>	215,00
	GR014	VK4105/M-2071 Modureg <b>Saunier Duval</b>	360,00
	GR022	VK4105/M-5108 Modureg <b>Baxi Luna-Eco</b>	176,00
GR003	VK4105/N-2013 Modureg <b>Unical, Sile, Ferroli, Ici, Sylber</b>	270,00	

### Honeywell automatiche

			EURO
	GR008	VR4605/AA-1003 <b>Beretta, Immergas</b> Adattabile <b>Ocean</b>	354,00
	GR009	VR4605/CA-1027 (Ex 1068) <b>Unical, Ferroli, Immergas, Cosmogas</b> Adattabile <b>Ici, Sime, Savio, Sile, Radiant, Lamborghini</b>	340,00
	GR021	VR4605/NA-2031 moduleg 28 Vcc <b>Unical</b>	240,00

### Honeywell IN ESAURIMENTO

			EURO
	GR001	V4600/C-1193 - 1/2" Ex 1029 - Fiamma pilota <b>IN ESAURIMENTO</b>	414,00
	GR006	VR4705/C-4013 - <b>Radiant Immergas, Cosmogas,</b> Adattabile <b>Ferroli e Vaillant</b> <b>IN ESAURIMENTO</b>	285,00
	GR007	VR4705/A-4023 <b>Immergas, Beretta, Riello</b> <b>IN ESAURIMENTO</b>	285,00

Modelli VR-VK/N e /Q adattabili con VR/C (Apertura lenta)  
Modelli VR-VK/M e /P adattabili con VR/A (Apertura rapida)

**Chiave di lettura Bobine Modulanti**  
**High/Low** - Nera, 230 Vac  
**Moduleg** - Bianca, 17 Vcc  
**Moduleg** - Verde, 28 Vcc

### Ricambi ed accessori

			EURO
	GR051	Q313A -Termopila per VS8820A - Cavi 900 mm	192,00
	GR025	Connettore raddrizzato per VK4105/...	25,00

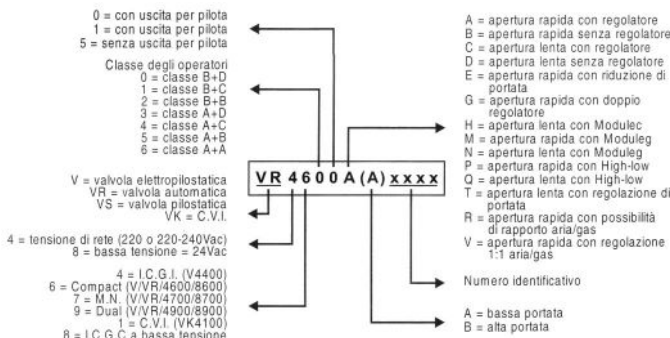

**SIT serie Sigma 848**

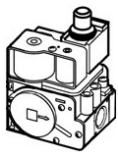
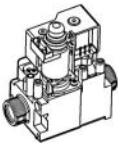
			EURO
	GR170	SIGMA 848.054 Flangiata <b>Baxi Luna HT</b>	210,00
	GR173	SIGMA 848.079 Flangiata <b>Sile condensa</b>	255,00
	GR171	SIGMA 848.107 3/4" M <b>Hermann, Vaillant</b>	186,00
	GR172	SIGMA 848.160 (Ex 022) 3/4" M <b>Riello, Baretta, Elco</b>	226,00

**SIT serie Sigma 845**

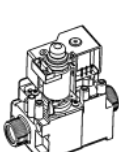
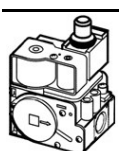
			EURO
	GR150	SIGMA 845.070* - 3/4" M <b>Riello, Sime, Hermann, Rhoss, Ariston, Unical, Robur, Tata</b>	120,00
	GR151	SIGMA 845.063 (ex 109) 3/4" M - <b>Immergas, Baxi</b> Interc.845.012 <b>Hermann</b>	120,00
	GR152	SIGMA 845.131 (ex 048) Flangiata <b>Baxi</b>	228,00

\*Il modello SIGMA 845.070 puo' sostituire i modelli  
845.057, 845.058 e 845.108

**SIT automatiche**

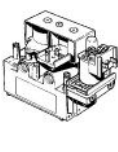
			EURO
	GR116	NOVA 830.035 - 1/2" Portata e L.A.regolabile Intercambiabile 830.034 <b>Intercamb.832.030&lt;70kW</b>	221,00
	GR118	NOVA 830.030 - 1/2" Uscita pilota, portata e L.A. regolabile <b>IN ESAURIMENTO</b>	234,00
	GR142	NOVA 832.030 - 1/2" <b>Bobine in classe A</b> Portata e L.A.regolabile <b>Per bruciatori pot.&gt;70kW</b>	364,00
	GR113	NOVA 836.010 - 1/2" Modulazione a gradino 230V <b>Ecoflam, Robur</b>	386,00
	GR110	NOVA 837.010 - 1/2" Bobina modulante 16V CC	386,00
	GR106	NOVA 837.013 Tandem Bobina modulante 28Vcc <b>MTS, Ariston</b>	386,00

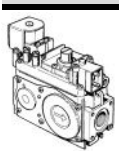
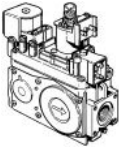
			EURO
	GR130	NOVA 822.110 - 1/2" Intercambiabile 822.114	372,00
	GR103	NOVA 826.011 - 1/2" Modulazione a gradino 230V <b>Lamborghini, Vaillant, Robur</b>	453,00
	GR111	NOVA 827.111 - 1/2" Bobina modulante 28V CC <b>Ferrolti, Sime, Unical</b>	447,00



**Ricambi ed accessori**

			EURO
	GR119	Bobina EV2 operatore per NOVA 820, 822, 824, 825, 826, 827	63,00
	GR146	Bobine operatore EV1 per 845, 848 Sigma	88,00
	GR124	Bobina operatore doppia per mod. 830, 832, 837	152,00
	GR126	Bobina EV1 operatore per NOVA 822, 826, 827	52,00
	GR143	Bobina modulatore 28V CC blu per 825, 827, 837	64,00
	GR144	Bobina modulatore 16V CC bianca per 825, 827, 837 <b>IN ESAURIMENTO</b>	47,00
	GR145	Bobina modulatore 220V RAC nera/verde per modelli 825, 826, 827, 836, 837	53,00
	GR138	Cartuccia metano 2-20mbar Bianca - 825, 827, 837 <b>IN ESAURIMENTO</b>	67,00
	GR139	Cartuccia multigas 3-37mbar Rossa - 825, 827, 837 <b>IN ESAURIMENTO</b>	67,00
	GR160	Chiave di regolazione SIT <b>IN ESAURIMENTO</b>	52,00
	GR127	Connettore con cavo cm.100 per modelli 830 - 832 - 837	41,00

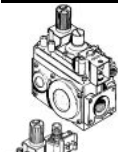
**SIT elettropilostatiche**

			EURO
	GR107	NOVA 820.011 - 1/2" F	285,00
	GR131	NOVA 825.011 - 1/2" F Bobina modulante 28V CC	385,00

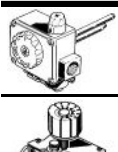
**SIT per scaldabagni, radiatori e stufe**

			EURO
	GR105	AC3 610.001 <b>IN ESAURIMENTO</b>	374,00
	GR122	EUROSIT 630.100 Campo regolazione bulbo 40/72°C	217,00
	GR125	EUROSIT 630.011 Campo regolazione bulbo 13/38°C	217,00





**WHITE RODGERS - Radiatori e scaldabagni**

			EURO
	GR906	Elettrovalvola 25M42M-13a* Universale <b>Sostituisce 02a, 12a, 15a, 16a</b>	138,00
	GR907	Ponte rettificatore universale per 13a	15,00

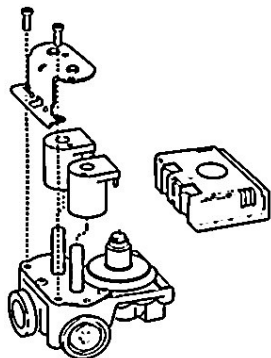
**ATTENZIONE!**  
Il modello 73a è fuori produzione e non può essere  
sostituito col modello 13a!

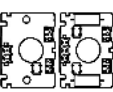

**Ricambi ed accessori**

			EURO
	GR910	Bobina 110V Terminali a spillo (Per 12a-15a-16a)	35,00
	GR911	Bobina 220V Terminali a spillo (Per 73a)	38,00
	GR912	Bobina 110V Terminali a faston (Per 5a - 13a)	33,00
	GR905	Schedina raddrizzatore (specificare spina 2 o 3 pin)	54,00

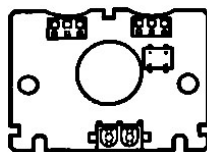



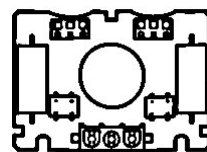

2 PIN  
x bobine GR910



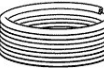

3 PIN  
x bobine GR911

**BRUCIATORI PILOTA**

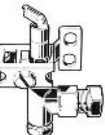
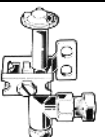
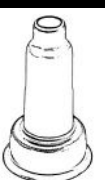
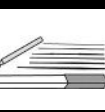
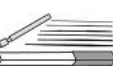
			EURO
	GR010	Bruciatore pilota Q334/A Honeywell	25,00
	GR135	Bruciatore pilota Monogas 3 fiamme verticali <b>Tipo A IN ESAURIMENTO</b>	19,00
	GR136	Bruciatore pilota Monogas 3 fiamme verticali <b>Tipo B Staffa L IN ESAURIMENTO</b>	14,00
	RN142	Tubo rame x tubo pilota Ø6x4mm - Matassa mt.2,5	28,00
	GR129	Raccordo con bicono Ø6mm pilota (Specificare ASA/SIT)	3,00
	GR140	Ogive per bicono Ø6mm Confezione pz.10	24,00

			EURO
	GR115	Bruciatore pilota universale 1 fiamma 2 impronte <b>IN ESAURIMENTO</b>	12,00
	GR132	Bruciatore pilota universale 2 fiamme 2 impronte <b>IN ESAURIMENTO</b>	12,00
	GR016	Ugello pilota MTN	11,00
	GR019	Ugello pilota GPL	23,00
	GR500	Kit 12 Alesatori per ugelli	90,00

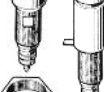
**ACCENDITORI E TRASFORMATORI**



			EURO
	GR571	Accenditore piezoelettrico Ø18mm	9,00
	GR572	Accenditore piezoelettrico Ø22mm	17,00
	GR137	Accenditore piezoelettrico per scaldabagni	17,00

			EURO
	RT015	COFI TRK2 - 100% 2 poli x 12KV - 35mA <b>Cosmogas serie "dens"</b>	40,00
	GR325	Accenditore HT 15kV - 230V <b>BRAHMA TSM</b>	28,00
	GR330	<b>BRAHMA AR1</b> Amplificatore della corrente di ionizzazione	38,00

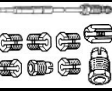
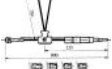
**TERMOCOPPIE****Universali in busta**

			EURO
	GR202	BASE - mm.900 5 raccordi	18,00
	GR121	SIT 208.002 - mm.900 8 raccordi	19,00
	GR205	DOUBLE interrotta bifilare 8 raccordi - L=mm.900 Cavi a saldare L=mm.750	24,00

**Termocoppie specifiche**

			EURO
	GR811	Raccordo ASA - mm.750 doppio dado Giunto <b>Honeywell - Sile</b>	36,00
	GR801	Raccordo ASA - mm.750 doppio dado Giunto <b>Ferrolli</b>	15,00

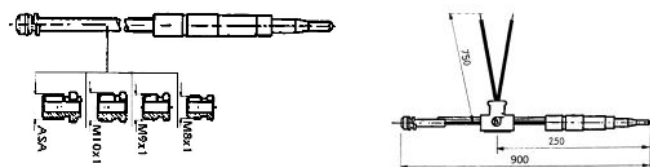
**Unificate Passo M9x1 - SIT**

			EURO
	GR502	Termocoppia mm.320	7,00
	GR503	Termocoppia mm.600	9,00
	GR504	Termocoppia mm.850	9,00

**Unificate Passo ASA - Honeywell**

			EURO
	GR512	Termocoppia mm. 450	8,00
	GR513	Termocoppia mm. 600	9,00
	GR514	Termocoppia mm. 850	9,00
	GR515	Termocoppia mm. 1500	10,00

**Prolunghe ed accessori**

			EURO
	GR805	Prolunga termocoppia ASA mm.450	18,00
	GR804	Prolunga termocoppia SIT mm.600	8,00
	GR555	Raccordo interrotto M9x1 Faston 6,3mm <b>IN ESAURIMENTO</b>	10,00
	GR556	Raccordo interrotto ASA Faston 6,3mm <b>IN ESAURIMENTO</b>	10,00
	GR527	Raccordo fissaggio termocoppie M10x1	3,00

**Raccordi per termocoppie**



			EURO
	GR523	Raccordo fresato M8x1	3,00
	GR522	Raccordo fresato M9x1 SIT	3,00
	GR524	Raccordo fresato M10x1	3,00
	GR526	Raccordo fresato M11x1	3,00
	GR525	Raccordo fresato 11/32" ASA/Honeywell	3,00

**CANDELETTE DI ACCENSIONE E RILEVAZIONE**

			EURO
	GR560	Candela con cavo mm.700 e staffa - Ø7 x 85 mm	10,00
	GR559	Candela accensione Ø6,5 x 65 mm con staffa Innesto minifaston	12,00
	GR563	Candela Ø7x85mm Innesto Ø4mm Con staffa tipo Immergas	10,00
	GR141	Raccordo fissaggio candele	3,00

			EURO
	GR011	Candela con cavo mm.500 per Honeywell Q334A Ø6,5 x 65,5 mm	12,00
	GR561	Candela accensione Ø6,5 x 65,5 mm Innesto minifaston	10,00
	GR117	Cavetto candele-piezo mm.600 Terminali Ø2,4mm - Ø4mm	6,00

**ESTRATTORI FUMI****Imbocco rotondo Ø 56 mm**

			<b>EURO</b>
	CE031	Estrattore fumi E15-98/GR <b>RO</b> Ventola Ø97 <b>Unical, Cosmogas, Rhoss, Radiant, Lamborghini, Saunier Duval, Leblanc, Ferroli Domina 24, Ariston</b>	120,00
	CE033	Estrattore fumi E15-108/GR <b>RO</b> - Ventola Ø108 <b>Unical, Sile</b>	158,00
	CH001	Estrattore fumi EBM G2K097 <b>RO</b> Ventola Ø97 con fori venturi <b>Hermann, Idealclima</b>	100,00
	CE034	Estrattore fumi FIME GR800 <b>RO</b> - Ventola Ø97 Completo di boccaglio e 2 prese venturi pressostato	75,00
	CE032	Estrattore fumi E15-98/DR <b>RA</b> Ventola Ø97 <b>SaunierDuval, Sime</b>	117,00
	CE011	Estrattore fumi RLG108 <b>RA</b> Ventola Ø108 <b>Baxi Luna, Eco 240</b>	108,00

**Imbocco rotondo Ø 58 mm**

			<b>EURO</b>
	CE003	LN200/2C- <b>RO</b> Ventola Ø108 <b>Bongioanni, Ariston, Simat, Rhoss, Sile</b>	169,00
	CE004	LN200/2C- <b>RA</b> Ventola Ø108 <b>Immergas, Sime</b>	124,00

**Imbocco rotondo Ø 60 mm**

			<b>EURO</b>
	CE002	Estrattore fumi LN200 Con venturi <b>Sile</b>	169,00
	CE015	Estrattore fumi con venturi e staffa <b>AACO ET22 Sile</b>	152,00
	CE016	Estrattore fumi con venturi e staffa <b>AACO ET25 Sile</b>	156,00

**Imbocco rettangolare 52 x 60 mm**

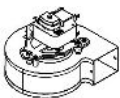
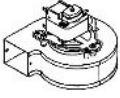
			<b>EURO</b>
	CE007	LN250/2C- <b>RA</b> Ventola Ø97 <b>Beretta, Riello, Ferroli, Fer</b> Per caldaie 24KW	70,00
	CE008	LN250/2C- <b>RA</b> Ventola Ø108 <b>Beretta, Riello, Fer, Ferroli, Junkers</b> - Per caldaie 28KW	72,00
	CE009	LN250/2C- <b>RO</b> Ventola Ø108 <b>Adattabile Vaillant VCW, VMW1</b>	115,00

**Imbocco quadrato 60 x 60 mm**

			<b>EURO</b>
	CE006	LN250/2C- <b>RA</b> - Ventola Ø97 <b>Beretta, Riello, Ocean, Immergas, Chaffoteaux</b>	120,00
	CE005	EBM/RLA108- <b>RA</b> 2 velocità Ventola Ø108 <b>Ocean FP</b>	186,00
<b>RO=Rotazione oraria - RA=Rotazione antioraria (lato ventola) - Adattabili, in certi casi recuperando alcuni dei componenti dal vecchio estrattore.</b>			

**PRESSOSTATI FUMI**







			<b>EURO</b>
	GP030	NORDGAS NS2 <b>Regolabile da 0,17 a 0,75 mbar</b> Con staffa Honeywell	24,00
	GP001	Honeywell <b>Reg.0,2/1mbar</b> C6065A/1028.2 <b>IN ESAURIMENTO</b>	75,00
	SP110	Tubo silicone 5x8 mm Mt.1	5,00
	SP111	Tubo silicone 7x10 mm Mt.1	7,00

			<b>EURO</b>
	GP010	HUBA - 0,47/0,35 mbar <b>Immergas, Ferroli, Fondital</b>	30,00
	GP016	HUBA - 1,05/0,90 mbar <b>Riello, Beretta</b>	30,00
	GP019	HUBA - 1,00/0,72 mbar <b>Vaillant</b>	30,00
	GP022	HUBA Control <b>Regolabile da 0,2 a 30mbar</b>	39,00
	SP115	Raccordo a Y per scarico condensa Pressostato	2,00

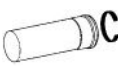

## TUBI ED ACCESSORI PER FUMISTICA IN PLASTICA PER CALDAIE A CONDENSAZIONE

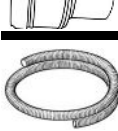

### Plastica PP Ø 80 mm - Sistema sdoppiato

			EURO
	IT002	Prolunga MF - cm.25	9,00
	IT003	Prolunga MF - cm.50	9,00
	IT004	Prolunga MF - cm.100	14,00
	IT005	Prolunga MF - cm.200	26,00
	IT009	Riduzione a bicchiere 80M - 60F	22,00
	IT010	Riduzione a bicchiere 60M - 80F	22,00
	IT060	Riduzione a bicchiere 80M - 50F	23,00
	IT061	Riduzione a bicchiere 50M - 80F	20,00
	IT051	Tubo flessibile giuntabile per controtubazioni. Ø80mm <b>Prezzo al metro.</b>	19,00

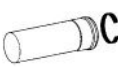
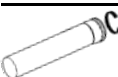
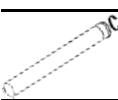
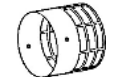

			EURO
	IT006	Curva 90° MF	8,00
	IT007	Curva 45° MF	8,00
	IT011	Raccordo a TEE - MMF	24,00
	IT012	Tappo scarico condensa per TEE	12,00
	IT043	Rosetta esterna in silicone Ø80mm	6,00
	IT040	Testina Pvc aspirazione aria	6,00
	IT041	Testina Inox per scarico fumi	15,00
	IT035	Guarnizione di ricambio a triplo labbro	6,00
	IT029	Collare Ø80mm con tassello	9,00
<p>Il tubo flessibile da Ø60 e da Ø80 è dotato di manicotti MF con la sede e la guarnizione per facili giunzioni ed accoppiamenti con la serie rigida in PP ed evita gli sprechi, dando così la possibilità di riutilizzare anche eventuali spezzoni.</p>			

### Plastica PP Ø 60 mm

			EURO
	IT013	Prolunga MF - cm.25	12,00
	IT014	Prolunga MF - cm.50	10,00
	IT015	Prolunga MF - cm.100	15,00
	IT024	Testina antivento Inox	16,00
	IT025	Rosetta in silicone Ø60mm	4,00

			EURO
	IT016	Curva 90° MF	10,00
	IT017	Curva 45° MF	10,00
	IT052	Tubo flessibile giuntabile per controtubazioni Ø60mm <b>Prezzo al metro</b>	18,00
	IT035	Guarnizione di ricambio a triplo labbro	6,00

### Plastica PP Ø 50 mm

			EURO
	IT053	Tubo flessibile Ø50mm per controtubazioni <b>Prezzo al metro</b>	15,00
	IT055	Riduzione a bicchiere 50M - 60F	28,00

			EURO
	IT054	Kit di adattamento giunzione rigido-flessibile Ø50mm, Ø60mm, Ø80mm	25,00

**FUMISTICA PER CALDAIE TRADIZIONALI - IN ESAURIMENTO****Alluminio smaltato bianco Ø 60 mm**

			EURO				EURO
	IT020	Curva 90° MF	21,00		IT019	Prolunga MF - cm.50	21,00
	IT021	Curva 90° FF	27,00		IT023	Prolunga MF - cm.100	28,00
	IT022	Curva 45° MF	18,00		IT028	Tronchetto giunzione FF	15,00

**Alluminio smaltato bianco Ø 80 mm - Sistema sdoppiato**

			EURO				EURO
	IT039	Prolunga MF - cm.25	11,00		IT036	Tronchetto giunzione FF cm.20	23,00
	IT031	Prolunga MF - cm.50	15,00		IT044	Riduzione a bicchiere 60/80 MF	21,00
	IT032	Prolunga MF - cm.100	25,00		IT047	Tronchetto raccogli condensa orizzontale MF	67,00
	IT030	Curva 90° MF	18,00		IT035	Guarnizione di ricambio a triplo labbro	6,00
	IT038	Curva 90° FF	24,00				
	IT033	Curva 45° MF	18,00				

**VETRINI PIREX PER CALDAIE**

			EURO
	RF400	Spessore 3mm - Ø30mm	7,00
	RF401	Spessore 3mm - Ø40 mm	18,00
	RF402	Spessore 3mm - Ø50 mm	20,00

**TAPPI E PRELIEVI FUMI**

			EURO
	SP920	Kit prelievi filettati mm 20 Passaggio mm.8 Pz.10	36,00
	SP921	Kit prelievi filettati mm 45 Passaggio mm.8 Pz.10	39,00
	SP900	Kit prelievo filettato mm.35 Passaggio mm.11 <b>PZ.1</b>	39,00
	SP998	Tappi foro camino in silicone ad espansione - Pz.10	38,00

**MANTELLI COPRICALDAIA**

			EURO
	AR100	Airone C05/SL H870 x L480 x P350 mm <b>IN ESAURIMENTO</b>	196,00
	AR101	Airone C25/SL H1020 x L550 x P450 mm	206,00
	AR102	Airone C26/SL H1020 x L650 x P450 mm	219,00
	AR103	Airone C36/SL H1270 x L650 x P450 mm	235,00
	AR105	Airone C53/SL H1100 x L700 x P530 Per caldaie con accumulo	238,00

Lamiera zincata con smaltatura esterna termoindurente. Coibentazione spessore 25mm in lana di vetro trattata con resine termo-indurenti. Fornito in kit di montaggio.

N.B. Le misure riportate sono esterne.





## APPARECCHI DI GESTIONE CONDENSA ACIDA

### POMPE SCARICO CONDENSA

			EURO
	IT101	Aspen Kitchen Boiler Con contatto di blocco Montaggio sottocaldaia	221,00
	IT117	Sauermann SI 61 - Per caldaie a condensazione fino a 50KW	235,00
	IT103	Sauermann SI 83 ex SI82 Con contatto di blocco e protezione surriscaldamento	156,00



**ASPEN Kitchen Boiler**  
L=182 x P=55 x H=115 mm  
Installazione sottocaldaia  
Alimentazione 230V  
Serbatoio lt.0,5  
Contatto allarme 3A max  
Portata massima 12 l/h  
Prevalenza max mt. 10  
**Rumorosità max 21 dB**

**SAUERMANN SI 61**  
L=168 x P=90 x H=88 mm  
Installazione a parete o a terra  
Alimentazione 230V  
Serbatoio lt. 0,37  
Contatto allarme 4A max  
Portata max 10 l/h  
Prevalenza max mt.8  
**Rumorosità max 28dB**

**SAUERMANN SI 83**  
L=287 x P=146 x H=129 mm  
Installazione parete e terra  
Alimentazione 230V  
Potenza 115W  
Serbatoio lt. 2,0  
Contatto allarme 5A max  
Portata max 700 l/h  
Prevalenza max mt.5,7  
**Rumorosità max 45dB**



**Hanna CHECKER PLUS:**  
Display digitale  
Campo di misura: 0/14 pH  
Precisione: +/- 0,2 pH  
Elettrodo sostituibile  
Alimentazione 1 batteria  
CR2032 1,5V

### Accessori e ricambi

			EURO
	IT108	Cartuccia PH Safe Neutralizzatore di acidità per Sauermann SI83 e SI82	72,00
	IT105	Valvolina di ritegno di Ricambio per SI1805 - SI83	10,00
	IT106	Tubo scarico condensa PVC Ø10mm interno - <b>Mt.1</b>	3,00
	AC219	Tubo scarico condensa PVC Ø6mm interno - <b>Mt.1</b>	2,00

**SAUERMANN PH-Safe**  
Cartuccia neutralizzante brevettata per installazione diretta nella pompa SI-83. Durata media 12mesi x una caldaia da 25kw  
Può neutralizzare in 1 anno fino a lt.800 di condensa acida.  
A Viraggio di colorazione.

### CONTROLLO PH Acidità

			EURO
	SA722	Cartine tornasole PH per controllo acidità condensa Confezione Pz.50	18,00
	SA724	<b>PHmetro Digitale</b> HANNA Checker-Plus Misura l'acidità residua	63,00
			<b>NETTO</b>

### NEUTRALIZZATORI CONDENSA ACIDA





			EURO
	IT116	Aspen Mondeo Acid Neutralizer Small Attacchi a stringere Ø20 <b>Per caldaie fino a 70kW</b>	78,00
	IT118	Euroacque MININEUTRO Attacchi portagomma Ø20 Qmax 3 lt/h - L=230mm <b>Per caldaie fino a 30kW</b>	69,00
	IT107	RBM NT1 - Qmax 3 lt/h Attacchi portagomma Ø20 L=160mm H=136mm <b>Per caldaie fino a 35kW</b>	107,00
	IT119	Sali ricambio MININEUTRO Sacchetto per una ricarica	25,00
	IT104	Sali ricambio NT1 Sacchetto per una ricarica	26,00
	IT111	Cartuccia ricambio per Cillit KKN S-N	184,00
	IT113	Cartuccia ricambio per Cillit KKN Medium e M-N	225,00

#### **RBM NT1 - RICARICABILE**

Munito di sfiato atmosferico come previsto dalla norma UNI7129-05. Obbligatorio installare in posizione verticale.  
**Durata media alla massima potenza 1 anno**

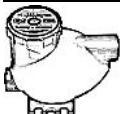
#### **Euroacque MININEUTRO - RICARICABILE**

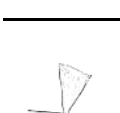
Comprende 2 attacchi da 20mm dritti, 1 a gomito, e 2 supporti. **Durata media 9 - 12 mesi**

			EURO
	IT114	Cillit KKN Colombo 11/20 Portata 56lh - Attacchi 3/4" M L410xH280xP225mm <b>Per caldaie fino a 350kW</b>	368,00
	IT091	Ferrari 350 Portata 35l/h - Attacchi 1" M L320xH240xP200mm <b>Per caldaie fino a 350kW</b>	378,00
	IT092	Ferrari 1500 Portata 150l/h - Attacchi 1" M L420xH240xP300mm <b>Per caldaie fino a 3000kW</b>	553,00
	IT115	Sali ricambio granulato Confezione 5 kg	64,00
	IT095	Sali ricambio granulato Confezione 10 kg	102,00
	IT096	Sali ricambio granulato Confezione 25 kg	315,00

#### **Aspen Mondeo - USA E GETTA**

Attacchi a stringere per tubo da 20mm.  
Portata Massima 2 lt/h. **Durata media 12 mesi**



**FERRARI 350: Durata 4450h a pieno carico**  
**FERRARI 1500: Durata 1800h a pieno carico**  
**COMPLETI DELLA PRIMA RICARICA**





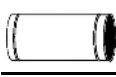
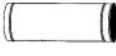

## TUBI ED ACCESSORI PER FUMISTICA INOX PARETE SEMPLICE PER CANALI DA FUMO - IN ESAURIMENTO



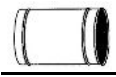

### Ø 120 mm - con guarnizione

			EURO
	IT120	Prolunga MF - cm.25	15,00
	IT121	Prolunga MF - cm.50	21,00
	IT122	Prolunga MF - cm.100	30,00





			EURO
	IT123	Curva MF - 90°	22,00
	IT124	Curva MF - 45°	21,00
	IT126	Curva MF - 90° Regolabile da 0° a 90°	58,00





### Ø 130 mm - con guarnizione

			EURO
	IT130	Prolunga MF - cm.25	16,00
	IT131	Prolunga MF - cm.50	22,00
	IT132	Prolunga MF - cm.100	32,00
	IT137	Rosetta inox Ø130	11,00

			EURO
	IT133	Curva MF - 90°	26,00
	IT134	Curva MF - 45°	23,00
	IT135	Curva MF - 30°	23,00
	IT136	Curva MF - 90° Regolabile da 0° a 90°	59,00
	IT138	Riduzione Ø130F/120M mm	48,00



### Ø 140 mm - con guarnizione

			EURO
	IT140	Prolunga MF - cm.25	17,00
	IT141	Prolunga MF - cm.50	23,00
	IT142	Prolunga MF - cm.100	34,00
	IT147	Rosetta inox Ø140	11,00

			EURO
	IT143	Curva MF - 90°	26,00
	IT144	Curva MF - 45°	23,00
	IT145	Curva MF - 30°	23,00
	IT146	Curva MF - 90° Regolabile da 0° a 90°	65,00
	IT148	Riduzione Ø140F/130M mm	52,00

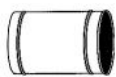
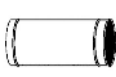
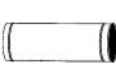
### Ø 150 mm - con guarnizione

			EURO
	IT150	Prolunga MF - cm.25	17,00
	IT151	Prolunga MF - cm.50	24,00
	IT152	Prolunga MF - cm.100	36,00

			EURO
	IT153	Curva MF - 90°	28,00
	IT154	Curva MF - 45°	24,00
	IT156	Curva MF - 90° Regolabile da 0° a 90°	67,00

### Placca fumi Ispesl

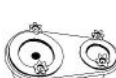
			EURO
	SC103	Placca controllo e prelievo fumi ISPEL (senza termometro)	58,00

	IT159	Raccordo a TEE Specificare Ø130, 140, 150	80,00
---	-------	--	-------

Tubazioni in acciaio inox Aisi316L , spessore 0,4 mm  
EN 1856-2 Temp.max con guarnizione 160°C  
EN 1856-2 Temp.max senza guarnizione 600°C  
Prezzi comprensivi di guarnizione al silicone

**VALVOLE FLUSSOSTATICHE****GIANNONI**

			<b>EURO</b>
	TP201	3vie <b>Lamborghini Inova</b>	178,00
	TP202	3vie con micro <b>Arca, Idealclima Attacchi Tipo S</b>	178,00
	TP203	3vie con micro <b>Wolf, Arca, Sile Turbinox Attacchi Tipo O</b>	178,00
	TP204	3vie con micro <b>MTS, Ariston, Simat, Radi</b>	178,00
	TP205	3vie con micro <b>Lamborghini, Joannes</b>	178,00

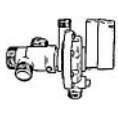

**MUT**

			<b>EURO</b>
	TP001	VDP 3vie <b>TIPO O</b> Intercambiabile Giannoni <b>Sime, ICI</b>	152,00

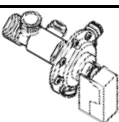







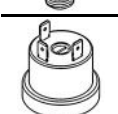
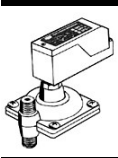

**GIANNONI "SPECIALI"**

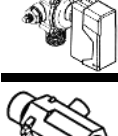
			<b>EURO</b>
	CI002	3vie innesti rapidi e rubinetto carico <b>Immergas Mini</b>	178,00
	CH007	3vie innesti rapidi con micro <b>Hermann Spazio tekno, Micra e Supermicra, Baltur Colibri</b>	178,00

**Ricambi**

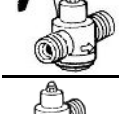
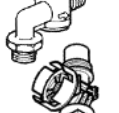
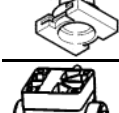
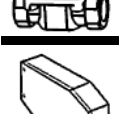
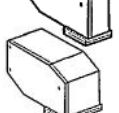
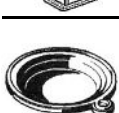
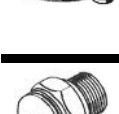
			<b>EURO</b>
	TP004	Membrana intercambiabile GIANNONI - Completa di alberino e tenute	14,00
	TP014	Membrana ricambio per MUT VDP - Completa di alberino, piattello e molla	30,00
	TP013	Scatola microinterruttore doppio Ricambio per VDP	31,00

**FLUSSOSTATI E PRESSOSTATI**

			<b>EURO</b>
	TP050	<b>CEME</b> - Pressostato 1/8" M Sicurezza mancanza acqua Prearato 0,45 bar Contatti in scambio	19,00
	TP051	<b>MATER</b> - Pressostato 1/4" M Sicurezza mancanza acqua Prearato 0,5 bar Contatti in scambio	18,00
	TP010	<b>Mut SFS1</b> - Pressostato differenziale a membrana 1/4" M - Micro singolo <b>Disponibile anche 1/4" SAE</b> per gruppi frigo	85,00
	TP009	<b>Caleffi 315 NAV</b> Flussostato a paletta 1/2" M	58,00
	TP008	<b>Caleffi 315 NAV</b> Flussostato a paletta 3/4" M	136,00
	TP011	<b>Mut SFP1</b> - 1/2" M Flussostato a membrana Micro singolo	98,00
	TP005	<b>Giannoni SF11</b> - 1/2" M Flussostato a membrana Micro doppio <b>Hermann-Lamborghini</b>	75,00
	TP022	<b>Bitron</b> Flussostato magnetico Attacchi 1/2" M verticale	24,00
	TP024	<b>Eltek 1/2" M</b> Flussometro in PVC <b>Ferrolì, Lamborghini, Unical</b>	30,00
	TP020	<b>Honeywell C7195A/2001</b> 1/2" M Sensore di portata (Flussometro)	34,00
	TP021	<b>Caleffi 316</b> Flussometro 1/2" M Sensore portata in ottone	33,00
	TP023	Sensore portata ad angolo 1/2" M ottone (Flussometro) <b>Fer-Ferrolì</b>	48,00
	CV019	Flussostato rotativo <b>Vaillant, Hermann, Saunier Duval</b>	33,00
	TP018	Flussostato 3/4" M <b>Murali a condensazione</b> <b>Sile, Fondital</b>	78,00
	CM006	Microinterruttore singolo di ricambio per SF11	27,00
	TP012	Microinterruttore doppio di ricambio per SF11	20,00
	TP017	Scatola microinterruttore di ricambio per MUT SFS/SFP	41,00
	GR710	Membrana ricambio per Giannoni SF11 - <b>N°55</b>	5,00
	TP015	Kit revisione Mut SFS - SFP Membrana completa di gruppo magnetico	15,00
	TP006	Premistoppa per flussostato Dado 14mm + fresatura <b>Fugas, Giannoni SF11</b>	5,00

**CIRCOLATORI ELETTRONICI PER CALDAIE****ASKOLL/TACO - Interasse mm 130**

			EURO
	PC401	ES2 15/60-130 Attacchi 1" Prevalenza max mt. 6	309,00
	PC402	ES2 25/60-130 Attacchi 1"1/2 Prevalenza max mt. 6	309,00

**GRUNDFOS - Interasse mm 130**

			EURO
	PC603	ALPHA 1L - 15/60-130 Con PWM - Attacchi 1" Prevalenza max mt. 6	CHIEDERE
	PC604	ALPHA 1L - 25/60-130 Con PWM - Attacchi 1"1/2 Prevalenza max mt. 6	CHIEDERE



**ONE PUMP - Interasse mm 130**

			EURO
	PC710	GPA 7,5 III Pro Attacchi 1" Prevalenza max mt.7,5	170,00
	PC711	GPA 7,5 III Pro Attacchi 1"1/2 Prevalenza max mt.7,5	173,00

**WILO - Interasse mm 130**

			EURO
	PC130	PARA 15/6 Attacchi 1" Prevalenza max mt. 6	195,00
	PC131	PARA 25/6 Attacchi 1"1/2 Prevalenza max mt. 6	195,00

**SOLO MOTORE**

			EURO
	PC720	DUCA BPE-G - Kit motore elettronico con cavi - mt.8,5 <b>Intercambiabile Grundfos</b>	160,00
	PC721	DUCA BPE-W - Kit motore elettronico con cavi - mt.8,5 <b>Intercambiabile Wilo</b>	160,00
	PC605	GRUNDFOS ALPHA 1 15/60 Ricambio originale Per sostituire motori UPS	350,00

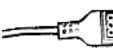
	PC506	Connettore Molex Cavo L=700mm	7,00
---	-------	----------------------------------	------

**Bocchettoni zincati**

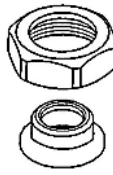
			EURO
	PC301	Coppia bocchettoni 1/2" F - 1" F	34,00
	PC302	Coppia bocchettoni 1"1/2 F - 3/4" F	45,00
	PC303	Coppia bocchettoni 1"1/2 F - 1" F	28,00

**CIRCOLATORI TRADIZIONALI PER CALDAIE****WILO - solo motore**

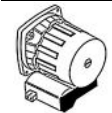
			EURO
	PC115	R12/6 - Girante Speciale Alta prevalenza Adattabile Vaillant, Ferroli, Lamborghini	174,00

**ONE PUMP - Interasse mm 130**



			EURO
	PC120	GPD 15/6 - Attacchi 1" Con separatore d'aria Motore intercambiabile Grundfos UPS	140,00

**CARTUCCE PER VALVOLE 3 VIE E MOTORI**

			EURO
	CO014	Cartuccia 3vie Baxi Luna 3, Luna 3 Confort, Luna 3 HT	40,00
	CM008	Cartuccia 3vie MTS, Chaffoteaux, Baxi, Sime, Ecoflam, Savio	20,00
	CC024	Motore e cartuccia per 3 vie Adattabile CMI Nectra	65,00
	CF006	Motore e cartuccia per 3vie Ferroli, Joannes, Lamborghini	84,00
	CX001	Motore e cartuccia per 3 vie Adattabile VISSMANN	68,00

			EURO
	CR020	Cartuccia 3vie Beretta, Riello	46,00
	CV020	Cartuccia 3 vie motorizzata Hermann, Saunier Duval, Vaillant	59,00
	CV011	Valvola 3 vie motorizzata Vaillant VMW1-2	120,00
	CV021	Valvola 3 vie motorizzata Vaillant Ecotec Plus 3-5	106,00
	CV017	Motore per valvola 3vie Vaillant VMW Ecotec, Turbo/Atmoblock	24,00

**VALVOLE DEVIATRICI E ATTUATORI****HONEYWELL - Attuatori Serie VC**

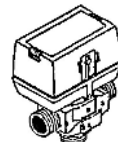
			<b>EURO</b>
	TZ101	VC6012 - SPDT Testata completa 230V/50Hz <b>Con morsettiera Molex</b>	143,00
	TZ107	VC6612 - 230V/50Hz <b>Micro e morsettiera Molex Intercambiabile VC6012</b>	109,00
	TZ109	VC4612/SPST - 230V/50Hz <b>Micro e morsettiera Molex</b>	254,00
	TZ103	VC6613 - 230V/50Hz <b>Con micro e cavo cm.100</b>	161,00
	TZ106	VC8610/SPST - 24V/50Hz <b>Micro e morsettiera Molex Buderus, Tata (Ex 8010)</b>	149,00
	TZ108	VC2010/SPDT - 24V/50Hz <b>Con morsettiera Molex</b>	106,00
	TZ035	Valvola VC6613MG6000 3vie 3/4"M - 220V <b>Con microinterruttore e Cavo cm.100</b> Connessione SPDT a 3 fili	286,00



**HONEYWELL - Serie VU**

			<b>EURO</b>
	TZ031	VU4143H-1001 - 2vie 3/4"F <b>Con microinterruttore</b>	180,00
	TZ032	VU4143H-1019 - 2vie 1"F <b>Con microinterruttore</b>	209,00

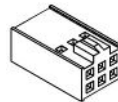
**Ricambi Honeywell**

			<b>EURO</b>
	TZ104	Otturatore flottante ricambio <b>per VC 3vie - VCZZ6000</b>	53,00
	TZ105	Otturatore flottante ricambio <b>per valvola VC 2vie VCZZ1000 - con chiave</b>	82,00
	TZ050	Connettore 3 fili x VC6012 Con cavo cm.100	10,00
	TZ051	Connettore 6 fili x VC6612 Con cavo cm.100	17,00

**Attuatori Valvole 3vie per caldaia**

			<b>EURO</b>
	TZ132	<b>Honeywell VJ6012ZZ 230V</b> Attuatore di ricambio <b>Gruppo Imar</b>	147,00
	TZ131	<b>ELBI 230V</b> Attuatore di ricambio	27,00
	TZ133	<b>ELBI Motore/Attuatore</b> <b>Beretta, Riello modelli vari</b> <b>Immergas modelli vari</b>	48,00



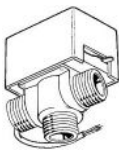

**MUT SF 3vie - Interc.Honeywell V4044**

			<b>EURO</b>
	TZ010	SF15 - 1/2"F	135,00
	TZ011	SF20 - 3/4"F	137,00
	TZ012	SF25 - 1"F	143,00
	TZ015	SF20/E - 3/4"M	138,00
	TZ016	SF25/E - 1"M	143,00

**MUT TMO a sfera - Ritorno motorizzato**

			<b>EURO</b>
	TZ041	TMO20-2MM SPDT M1S 3/4"M - 2 vie con micro Int. mm 135 con bocchettoni	151,00
	TZ042	TMO25-2MM SPDT M1S 1"M - 2 vie con micro Int. mm 155 con bocchettoni	153,00
	TZ045	TMO20MMM SPDT M1S 3/4"M - 3 vie con micro Int. mm 135 con bocchettoni	162,00
	TZ046	TMO25MMM SPDT M1S 1"M - 3 vie con micro Int. mm 155 con bocchettoni	175,00

**Ricambi MUT**

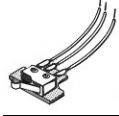
			<b>EURO</b>
	TZ141	Attuatore TMO 2 vie SPDT 220V <b>Con microinterruttore</b>	139,00
	TZ142	Attuatore TMO 3 vie SPDT 220V <b>Con microinterruttore</b>	142,00
	TZ145	Attuatore MUT VMR 24V <b>Intercambiabile Honeywell VC8010/8610</b>	105,00
	TZ140	Otturatore flottante ricambio <b>per valvola VMR 3vie</b>	43,00
	TZ022	Motorino Synchron 230V <b>per Honeywell serie V4043/V4044 e MUT SF</b>	79,00
	TZ021	Motorino Synchron 230V con staffa MUT - 2 vie	81,00
	TZ023	Motorino Synchron 230V con staffa MUT - 3 vie	81,00
	TZ024	Motorino Synchron 24V-AC con staffa MUT - 3 vie <b>Ecoflam</b>	94,00
	TZ020	Kit microinterruttore ausiliario M1 per SF	15,00

**VASI DI ESPANSIONE****Circolari piatti - Ø 325 attacco 3/4"**

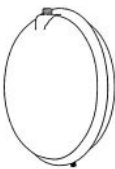
			EURO
	VE106	Vaso lt.6 - h118mm	56,00
	VE107	Vaso lt.8 - h132mm	57,00
	VE108	Vaso lt.10 - h150mm	60,00
	VE109	Vaso lt.12 - h170mm	63,00

**A disegno speciale - Ø 325mm**

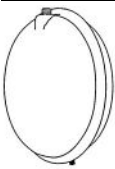
			EURO
	CO003	Vaso lt.6 - h100mm Attacco 14MA Adattabile Ocean 1° serie	56,00

**Rettangolari - Attacco 3/4" M - Precarica 1bar**

			EURO
	VE201	Cimm lt.6 512 x 196 x 100 mm	65,00
	VE205	Cimm lt.8 512 x 196 x 113 mm	67,00
	VE206	Cimm lt.10 512 x 196 x 128 mm	72,00
	VE207	Cimm lt.12 512 x 196 x 146 mm	75,00
	VE202	Zilmet lt.7,5 490 x 200 x 120 mm	116,00
	VE203	Zilmet lt.10 490 x 200 x 150 mm	130,00
	VE204	Zilmet lt.12 490 x 200 x 175 mm	133,00

**Rettangolari a disegno speciale**

			EURO
	VE116	Cimm lt.8 - 3/8" M 512 x 196 x 113 mm Adattab. Immergeas, Ferroli	67,00
	VE119	Zilio lt.6 - 3/8" M 490 x 200 x 65 mm	66,00

**Minicompressore POWERPLUS**

			EURO
	SP503	Minicompressore gonfiavasi <b>POWX1700</b>	80,00 NETTO
	SP507	Batteria di ricambio per POWX1700	38,00 NETTO

**Circolari piatti - Ø 387 attacco 3/4"**

			EURO
	VE101	Vaso lt.6 - h93mm	60,00
	VE102	Vaso lt.8 - h110mm	66,00
	VE103	Vaso lt.10 - h128mm	69,00
	VE104	Vaso lt.12 - h142mm	73,00
	VE105	Vaso lt.14 - h170mm	77,00



**A disegno speciale - Ø 387mm**

			EURO
	VE115	Vaso lt.8 - h90mm - 3/8" M Adattabile Immergeas, Ferroli, Unical	66,00
	CO004	Vaso lt.8 - h110mm Attacco 14MA Adattabile Baxi	66,00
	VE110	Vaso lt.10 - h120mm Attacco 1/4" M Adattabile Beretta Idra, Riello 2000	69,00
	VE118	Vaso lt.8 - 1/2" M - h75mm Ø392 - Beretta Exclusive, Mynute, Super Exclusive, Riello Nuova Benessere, Residence	69,00
	VE113	Vaso lt.10 - h128mm Attacco 3/4" M centrale Adattabile Unical GEA	69,00

**A disegno speciale - Ø 416mm**



			EURO
	VE114	Vaso lt.8 - h75mm 1/4" M Con staffa adattabile Beretta Idra Exclusive, Riello Benefit	84,00

**Raccordi adattatori x Vasi**

			EURO
	RN049	Manicotto di riduzione 3/8" M x 3/4" F	20,00
	RN050	Manicotto di riduzione 1/2" M x 3/4" F	18,00
	SP504	Prolunga flessibile cm.20 Per carico vasi	13,00

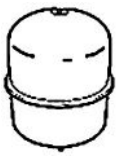
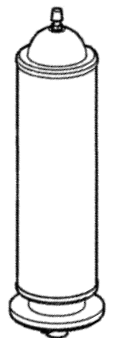

**Vasi Sanitari**

			EURO				EURO
	VE006	Cimm lt.2 - 1/2"M Ø120 x 240 mm <b>Adattabile Beretta, Riello, Immergas Zeus, Hercules</b>	41,00		VE010	Vaso sanitario CIMM Style lt.2 - Ø80 x 440 mm Attacco 1/2"M	83,00
	VE001	Cimm lt.5 - 3/4"M Ø170 x 275 mm	48,00		VE011	Vaso sanitario CIMM Style lt.3 - Ø90 x 560 mm Attacco 1/2"M	89,00
	VE021	Vaso sanitario ZILMET 564 lt.3 - L=450mm Sezione ovale - Att.1/2"M	141,00		VE012	Vaso sanitario CIMM Style lt.4 - Ø90 x 655 mm Attacco 1/2"M	102,00
	VE022	Vaso sanitario ZILMET 564 lt.4 - L=600mm Sezione ovale - Att.1/2"M	175,00				

**VALVOLE SICUREZZA KRAMER**

			EURO				EURO
	VE504	Valvola sicurezza 3 bar 1/2"F	9,00		VE524	Valvola sicurezza 3 bar <b>Attacco O.R. generico Adattabile Immergas, Baxi</b>	10,00
	VE506	Valvola sicurezza 6 bar 1/2"F	9,00		CR008	Valvola sicurezza 3 bar <b>Attacco O.R. Beretta/Riello</b>	11,00
	VE509	Valvola sicurezza 7 bar 1/2"F	9,00		CV013	Valvola sicurezza 3 bar a innesto rapido femmina per <b>Vaillant VM</b>	18,00
	VE505	Valvola sicurezza 3 bar 1/2"M	9,00		CM009	Valvola 3bar in composito Innesto O.R. - Uscita 3/8"M <b>MTS, CMI, Ecoflam</b>	14,00
	VE507	Valvola sicurezza 6 bar 1/2"M	9,00		VE532	Valvola 3bar in composito Innesto O.R. - Uscita 1/2"M <b>Baxi, Ferroli, HSD</b>	10,00
	VE525	Valvola sicurezza 7 bar 1/2"M	9,00		VE530	Testina di ricambio Kramer 3 bar	8,00
	VE508	Valvola sicurezza 3 bar 1/2"M - <b>Con presa portamanometro 1/4"F</b>	11,00	VE531	Testina di ricambio Kramer 8 bar	9,00	
	VE503	Valvola sicurezza 3 bar 1/2"F - <b>Con presa portamanometro 1/4"F</b>	11,00		RS011	Valvola di ritegno 1/2" - 8bar Con leva di scarico Per scaldabagno	22,00

**VALVOLE SFIATO ARIA**

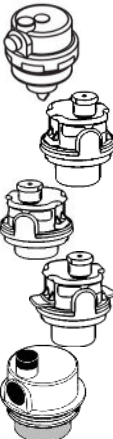
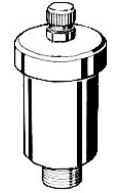

			EURO				EURO
	VE501	Caleffi Minical 5020 - 3/8" <b>Prezzi netti per quantita'</b>	15,00		VE523	Caleffi Robocal 3/8" <b>Prezzi netti per quantita'</b>	12,00
	VE490	Caleffi Minical 5020 - 1/2" <b>Prezzi netti per quantita'</b>	15,00		VE480	Caleffi in plastica a innesto rapido per Wilo e Grundfos <b>Prezzi netti per quantita'</b>	10,00
	VE502	Pintossi 507 - 3/8" <b>Prezzi netti per quantita'</b>	13,00		VE481	Caleffi in plastica a innesto rapido per Wilo e Grundfos <b>Ingombro ridotto Per circolatori elettronici</b>	15,00
	VE500	Pintossi 507 - 1/2" <b>Prezzi netti per quantita'</b>	13,00		VE482	Caleffi in plastica a innesto rapido con alette	15,00
					CO013	Caleffi - Testina Jolly filettata <b>Adattabile Baxi, Saunier Duval</b>	13,00





**RUBINETTI CARICAMENTO CALDAIA**

			EURO				EURO
	CR005	Rubinetto carico adattabile <b>MTS Ariston, Beretta, Riello</b>	16,00		CI006	Rubinetto di carico 104 mm Adattabile <b>Immergas, Hermann</b>	11,00
	VE521	Rubinetto di carico 37 mm Adattabile <b>Unical, Hermann, Radiant, Fondital Vela - Panarea</b>	10,00		CI013	Rubinetto carico adattabile <b>Immergas Eolo, Nike</b>	17,00
	CO012	Rubinetto carico adattabile <b>Baxi serie Luna, Eco</b>	25,00		CV003	Rubinetto carico adattabile <b>Ecoblock, VMW Plus 2-3-4, e TurboPlus 2-3-4</b>	18,00
	CO006	Rubinetto di caricamento manopola estraibile <b>Ariston, Baxi, Ecoflam</b>	9,00		CF013	Rubinetto carico 1/2"M-3/4"M adattabile <b>Ferrolì</b>	58,00
	VE528	Rubinetto di carico 60 mm Adattabile <b>Immergas Nuova Avio, Nova Florida Pictor, Fondital Tahiti</b>	11,00	<b>GRUPPO CARICO AUTOMATICO</b>			
	VE529	Rubinetto di carico 75 mm Adattabile <b>Hermann, Lamborghini</b>	11,00	<b>EURO</b>			
					CH003	Elettrovalvola caricamento CEME - 1/4"M x 1/2"M <b>Hermann serie Spazio, Unical Ipsen, Entrofuori, Enter</b>	40,00





**RUBINETTI SCARICO CALDAIA**

			EURO
	VE520	Rubinetto scarico caldaia 1/2"M con tappo	14,00
	VE540	Rubinetto scarico bollitore 1/2"M - Con tappo	8,00
	VE541	Rubinetto scarico orientabile per caldaie murali - 1/4"M	6,00

**GRUPPI DI CARICO**

			EURO
	CF010	Gruppo di caricamento <b>Ferrolì Domina, Igloo, Domitop DGT</b>	29,00
	CF011	Gruppo di caricamento <b>Ferrolì Domicompact, Ferella Zip</b>	33,00
	CF014	Gruppo di caricamento <b>Ferrolì Domitop, Ferella Gold</b>	26,00

**RUBINETTI MINIBALL**

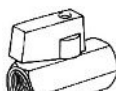
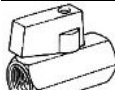
			EURO				EURO
	NF400	Rubinetto di carico a sfera 1/4" MF	8,00		NF405	Rubinetto di carico a sfera 3/8" MM	9,00
	NF403	Rubinetto di carico a sfera 1/4" MM	9,00		NF402	Rubinetto di carico a sfera 1/2" MF	8,00
	NF401	Rubinetto di carico a sfera 3/8" MF	8,00		NF406	Rubinetto di carico a sfera 1/2" FF	10,00
	NF404	Rubinetto di carico a sfera 3/8" FF	8,00				



## SCAMBIATORI A PIASTRE SALDOBRSATE

			EURO				EURO	
	CR012	Attacchi O.R. con labbro <b>14 piastre</b> Beretta, Riello, Rhoss, Baltur, Arca, Buderus	65,00		CI007	Attacchi filettati <b>13 piastre</b> Immergas Nike, Eolo Mini	84,00	
	CR019	Attacchi O.R. con labbro <b>16 piastre</b> Beretta, Riello	64,00			CI015	Attacchi filettati <b>14 piastre</b> Immergas Eolo Mini KW, Unical, Radiant, Fontecal	50,00
	CH005	Attacchi O.R. <b>14 piastre</b> Saunier Duval Thema Fast, Thema Classic	60,00			CS101	Attacchi O.R. <b>14 piastre</b> Sime Format, Format Zip, Murelle	191,00
	CO007	Attacchi O.R. <b>14 piastre</b> Ocean Luna, C.M.I. Nectra Saunier Duval Isofast	60,00		CV002	Kit completo di raccordi per sostituzione scambiatore originale in composito <b>14 Piastre</b> Vaillant VCW	100,00	
	CO009	Attacchi O.R. <b>14 piastre</b> Baxi Luna/Eco	60,00			CV009	Attacchi filettati <b>14 Piastre</b> Vaillant VCW Senza raccordi	66,00
	CO008	Attacchi O.R. <b>16 piastre</b> Baxi Luna/Eco	69,00			CV010	Attacchi a 3 innesti rapidi <b>14 Piastre Corto L=190mm</b> per Vaillant VMW3-5 - Pro	60,00
	CM002	Attacchi O.R. <b>14 piastre</b> Simat, Ariston, Ecoflam, Rhoss, Radi, Farel, Baxi, Tata Lady	61,00			CV016	Attacchi a 3 innesti rapidi <b>20 Piastre Corto L=190mm</b> per Vaillant VMW3-5 - Pro	84,00
	CM013	Attacchi O.R. <b>16 piastre</b> Simat, Ariston, Radi Modelli a pag. 6	63,00				CV012	Attacchi a 3 innesti rapidi <b>14 piastre - Lungo</b> per Vaillant VMW3-5
	CM001	Attacchi O.R. <b>14 piastre</b> Chaffoteaux, Ariston Modelli a pag. 6	46,00		CV014		Attacchi O.R. con alette <b>14 piastre - Vaillant</b> Ecoblok Pro, Turboblock Plus	66,00
	CN002	Attacchi O.R. <b>14 piastre</b> Chaffoteaux, Ferroli, Fondital, Lamborghini (Ariston Modelli a pag. 6)	58,00			CV015	Attacchi O.R. con alette <b>20 piastre</b> Vaillant Ecoblok Pro, Plus	82,00
	CF005	Attacchi filettati 1/2-3/4" M <b>14 piastre</b> adattabile Hermann Spazio plus, Ferroli	60,00			CG001	Attacchi O.R. <b>12 piastre</b> Interasse tiranti 285mm Gruppo Imar	82,00
	CH011	Attacchi filettati <b>14 piastre</b> Sime Open, Format BF, Planet, Hermann Micra	83,00					

### Per separazione impianti

			EURO
	CP005	<b>28 Piastre</b> Attacchi filettati 3/4" M 40 KW -> ΔT30°C	102,00
	CP006	<b>40 Piastre</b> Attacchi filettati 3/4" M 60 KW -> ΔT30°C	129,00

Gli scambiatori di grossa portata CP005 e CP006 sono ideali per separare l'impianto dalla caldaia, in presenza di termocucine e termocaminetti.

**MISURE INTERASSI  
DEI TIRANTI PER  
MODELLI CON  
ATTACCHI A O.R.**



CH005	172 mm	CO007	178 mm
CI015	153 mm	CO008	157 mm
CM001	142 mm	CO009	157 mm
CM002	165 mm	CR012	147 mm
CN002	147 mm	CR019	147 mm

**TERMOMETRI A CAPILLARE**

			EURO				EURO
	TX001	Quadrante Ø42mm - Foro Ø37mm, capillare mm.1500 <b>Disponibile bianco o nero</b>	11,00		TX003	Quadrante rettangolare 65x30mm Foro 58x25mm <b>Colore nero - Unical</b>	11,00
	TX002	Quadrante Ø56mm - Foro Ø52mm, capillare mm.1500 <b>Colore nero</b>	11,00		TX007	Quadrante rettangolare 70x14mm - Foro 62x11mm <b>Colore nero Riello</b>	11,00
	TX004	Quadrante 42x42mm Foro Ø37mm <b>Colore nero Beretta Idra</b>	11,00		CV006	Quadrante 48x48mm Foro quadro 45x45mm <b>Colore nero Vaillant, Ecoflam</b>	46,00

**TERMOMETRI E PIROMETRI**

			EURO				EURO
	TX005	A immersione 0/120°C Ø63mm gambo 1/2" x 50mm <b>INAIL</b>	9,00		TX006	A bracciale cassa inox 0/120°C Ø63mm Completo di molla	8,00
	TX008	A immersione 0/120°C Ø80mm gambo 1/2" x 100mm <b>INAIL</b>	12,00		SC100	Pirometro <b>fumi</b> cassa inox 0/500°C Ø63mm gambo mm150	12,00
	TX009	A immersione 0/120°C Ø80mm Gambo 1/2" x 50mm Attacco radiale <b>INAIL</b>	66,00		SC010	Pirometro <b>fumi</b> cassa inox 0/500°C Ø63mm gambo mm200	13,00
				<b>Placca fumi Ipsesl</b>			
							EURO
	SC103	Placca controllo e prelievo fumi <b>INAIL</b> <b>IN ESAURIMENTO</b>					58,00

**IDROMETRI A CAPILLARE E MANOMETRI**

			EURO				EURO
	TI001	Quadrante Ø42 mm Foro Ø37 mm - 1/4"M <b>Colore nero</b>	14,00		VE603	Manometro 0/4 bar Ø50mm Attacco radiale 1/4"M	13,00
	TI002	Quadrante Ø56 mm Foro Ø52 mm, 1/4"M <b>Colore nero</b>	14,00		VE604	Manometro 0/10bar Ø50mm Attacco radiale 1/4"M	13,00
	TI004	Quadrante 42x42mm Foro Ø37 mm, 1/4"M <b>Colore nero Beretta Idra</b>	14,00		VE605	Manometro 0/6 bar Ø50mm Attacco posteriore 1/4"M	17,00
					VE606	Manometro 0/4 bar Ø40mm Attacco posteriore 1/8"M <b>Radiant, FBR, Hermann</b>	10,00

**TERMIDROMETRI A CAPILLARE**

			EURO				EURO
	TI003	Quadrante Ø56mm Foro Ø52mm - Att. 1/4"M <b>Colore nero</b>	21,00		CI008	Quadrante Ø44mm Foro Ø40mm - Att. 1/4"M <b>Colore bianco Immergas, Ferroli</b>	21,00
	TI005	Quadrante Ø56mm Foro Ø52mm - Att. 14MA <b>Disponibile Bianco o nero</b>	21,00		TI006	Quadrante Ø46mm Foro Ø42mm - Att. 1/4"M <b>Colore bianco Hermann, Riello Domus</b>	21,00
	TI010	Raccordo fresato adattatore per idrometri Passo gas 1/4" o 14MA	13,00				

**TERMOSTATI A CAPILLARE****Regolazione 3 contatti**

			EURO
	TT106	TR2 - 0/40°C Capillare mm.1000 Con manopola e ghiera	38,00
	TT105	TR2 - 0/65°C Cap.mm.1500 Rivestito PVC Con manopola e ghiera	32,00
	TT103	TR2 - 0/90°C <b>INAIL</b> Cap.mm.1500 Rivestito PVC Con manopola e ghiera	36,00

**Regolazione speciali**

			EURO
	TT101	TR2 Regolabile 30/90°C Capillare mm.1500 <b>Regolazione cacciavite</b>	36,00
	TT132	Regolabile 30/110°C Capillare mm.1500 Con manopola e ghiera	32,00
	TT130	Regolabile 30/160°C Capillare mm.1500 Con manopola e ghiera	32,00
	TT133	Regolabile 50/200°C Capillare inox mm.1500 bulbo Ø3mm Con manopola e ghiera	32,00
	TT131	Regolabile 50/350°C <b>2 contatti Norm. Chiusi</b> Capillare inox mm.1500 bulbo Ø3mm Con manopola e ghiera	46,00
	TT110	IMIT regolazione 0/90°C Inscatolato Capillare mm.1000	80,00
	TT010	Pozzetto ricambio 1/2" Varie lunghezze Disponibile per 1 o 3 sonde	21,00

**Termostati sicurezza**

			EURO
	TT104	LS1 - Riarmo manuale 100°C - <b>3 contatti INAIL</b> Cap.mm.1500 Rivestito PVC	36,00
	TT108	LS1 - Riarmo manuale 100°C - <b>2 Contatti dorati</b> Capillare 1000mm	41,00
	TT109	LS3 - Riarmo automatico 100°C - <b>2 Contatti dorati</b> Capillare 1000mm	40,00

**BITERMOSTATI generatori d'aria calda**











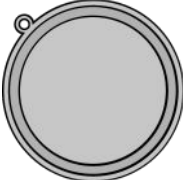

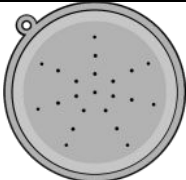

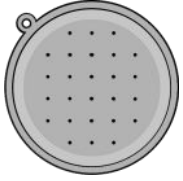

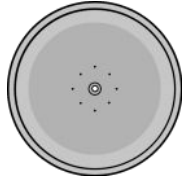
			EURO
	TB002	IMIT TTCA/870 Regolazione ventilatore esterna 0-60°C - L280mm	136,00
	TB104	HONEYWELL L4064B2210 - L=290mm comando ventilatore Scala in gradi Fahrenheit F° <b>Sostituisce vecchi modelli B1725 e N1074</b>	242,00

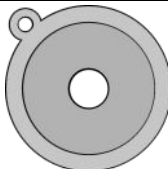
**TERMOSTATI A MICROCONTATTO**

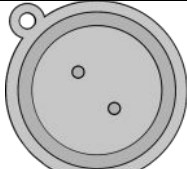
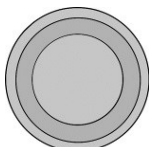
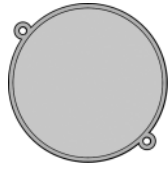
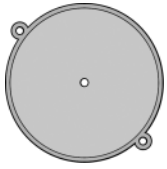
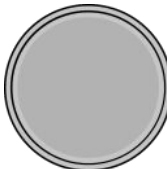
			EURO
	TK003	T3 - <b>Antigelo NA</b> Inserimento + 3°C disinserimento + 16°C	7,00
	TK015	<b>Kit blister 42°C NA</b> con cavi e staffa per il fissaggio tra le alette della batteria alettata dei convettori	13,00
	TK010	T40 - 42°C <b>NA</b> Per ventilconvettori Con molla fissaggio al tubo	7,00
	TK009	T60 - 60°C <b>NA</b> Per ventilconvettori Con molla fissaggio al tubo	7,00
	TK011	T70 - 70°C <b>NC</b>	7,00
	TK014	T80 - 80°C <b>NC</b>	7,00
	TK012	T90 - 90°C <b>NC</b>	7,00
		GR441	T105 - 105°C <b>NC</b> <b>Contatti dorati</b>
TK013		T110 - 110°C <b>NC</b> <b>Contatti dorati</b>	7,00
TK016		T120 - 120°C <b>NC</b> <b>Contatti dorati</b>	7,00
	TK035	Termostato fumi 75°C <b>NC</b> <b>Contatti dorati</b>	7,00
	TK036	Termostato limite a riarmo manuale 140°C <b>NC</b> <b>Ventilconvettori</b>	17,00
	TK101	Pasta per contatti - gr.50	7,00

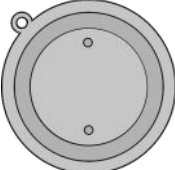
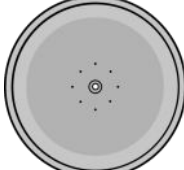
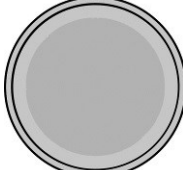
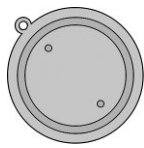

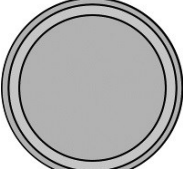
## MEMBRANE PER CALDAIE E SCALDABAGNI

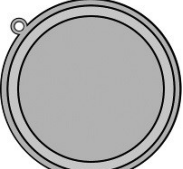
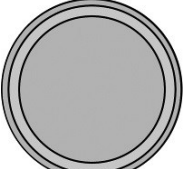
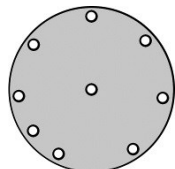
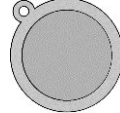
			EURO	Per richiedere le membrane verificare misure, forma, aspetto e referenze, indicare il numero identificativo riportato in ogni riquadro in alto a sinistra. Disponibili anche altri modelli.							
	GR710	Membrana per caldaia o scaldabagno	5,00								
3		Ø88 - BERETTA Paros	55		Ø44 - BERETTA Paros, MTS, HERMANN, BAXI, LAMBORGHINI	76		Ø90 - BERETTA Idra, RIELLO 2000 Lato sanitario	67		Ø44 - BERETTA Idra, RIELLO 2000 Lato riscaldamento
75		Ø78 - BERETTA Meteo, Exclusive, Mynute	75A		Ø47 - BERETTA Idra Exclusive, Meteo, Mynute	71		Ø78 - RIELLO Benefit, Residence	12		Ø65, h=15 Scaldabagni BERETTA, RIELLO, SYLBER
70		Ø72 - Foro Ø11 IMMERGAS Super Nike, Super Eolo	72		Ø63 - IMMERGAS Nike, Eolo	82		Ø80 - IMMERGAS Major, Superior	46		Ø63 - UNICAL DUA C
15		Ø70 - Scaldabagno VAILLANT	66		Ø70 - VAILLANT VCW Lato sanitario	84		Ø75 - VAILLANT VCW Lato riscaldamento	85		Ø57 - VAILLANT VMW
69		Ø76 - OCEAN Solaria, 2002	83		Ø80 - OCEAN/BAXI Luna, Eco	86		Ø80 - MTS, ECOFLAM, RHOS	60		Ø63 - SAUNIER DUVAL
25		Ø55 - CHAFFOTEAUX et MAURY	43		Ø85 - CHAFFOTEAUX et MAURY G15-20-30, TIG	51		Ø56 - CHAFFOTEAUX et MAURY Bayard, Celtic, GM	58		Ø54 - CHAFFOTEAUX et MAURY Vecchi modelli
59		Ø87 - CHAFFOTEAUX et MAURY GS, GM, Celtic	65		Ø87 - CHAFFOTEAUX et MAURY Multi, M20, Cortina, RS	32		Ø75 - LEBLANC	7		Ø51, h=12 - JUNKERS

**ATTREZZI E PRODOTTI PER PULIZIA CALDAIE****Kit HYSRAY**

			EURO
	SA360	Kit pulizia scambiatori per caldaie a condensazione in alluminio e acciaio	148,00
	SA361	Liquido detergente alcalino Ricambio Lt.2 <b>Mechim - Hyspray EASY5</b>	16,00
	SA365	Pompa erogatrice ricambio	66,00

Il Kit SA360 comprende 2 lt di detergente liquido alcalino, un erogatore a pressione (necessario per l'utilizzo del prodotto), una spazzola, 1 set lame per pulizia lamelle, 1 tubo di scarico delle morchie.  
Adatto sia per scambiatori in alluminio/silicio che in acciaio.  
Il Set lame può essere richiesto come ricambio.

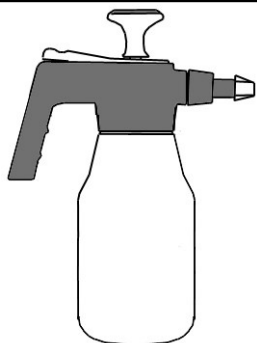
**MINICOMPRESSORE GONFIAVASI**

			EURO
	SP503	POWERPLUS POWX1700	80,00
	SP507	Batteria di ricambio per POWX1700	38,00
	SP504	Prolunga flessibile cm.20 Per carico vasi	13,00

**POWX1700**

Minicompressore gonfiavasi completo di batteria, manometro e tubo, fornito in valigetta.  
Tempo carica circa 1 h  
Peso (batteria inclusa) 1,1 Kg  
Portata 35 l/min  
Pressione massima 8 bar  
Batteria Li-Ion 18V - 1500mAh

**CONDIZIONANTI PER IMPIANTI**

			EURO
	SA421	CHEM TA100 POCKET Condizionante per impianti termici Busta da g.60	44,00
	SA440	CHEM TA65 ALLARM MAG Decapante pulitore protettivo Lt. 1	39,00

**TA100:** Polvere a triplice azione, protettiva anticorrosiva, deossigenante e algicida. 1 busta per impianti fino a lt.200

**TA65:** Liquido inibitore protettivo, solleva i depositi e i contaminanti nell'impianto e ne agevola il trasporto al filtro defangatore magnetico facilitando la raccolta di magnetite.

**STABILIZZANO IL PH**

Studiati per tutti i tipi di metalli e materiali plastici. Rimangono in modo permanente nell'impianto prevenendo la corrosione, le incrostazioni e la formazione di alghe.

**Kit CHEM**

			EURO
	SA362	TA88 - DECACOMB AL Specifico per alluminio/silicio Lt.1	50,00
	SA363	TA90 - DECACOMB Specifico per acciaio inox Lt.1	50,00

**CHEM DECACOMB TA88 e TA90**

Rimuove gli ossidi e i residui di combustione dalle superfici degli scambiatori di tutti i tipi di caldaie da riscaldamento penetrando in profondità.

Decomponi i depositi trasformandoli in composti volatili e lavabili dall'acqua.

Contiene degli speciali inibitori di corrosione che tengono sotto controllo l'attacco acido e rallenta il fenomeno della corrosione a carico delle superfici metalliche.

Contribuisce anche a ripristinare il corretto scambio termico.

Risciacquare abbondantemente con acqua.

**MODALITA' D'USO****A spruzzo:**

Rimuovere i residui più grossolani, applicare con l'erogatore, nebulizzare e lasciare agire per almeno 10 minuti.

**Per immersione (solo con TA88):**

Diluire in acqua al 30% e lasciare agire per max 15 minuti.

**PRODOTTI DETERGENTI**

			EURO
	SA165	PINECO Ecofiltri - Lt. 1 Specifico per filtri	30,00
	AC240	DK-SAN RTU - Lt. 1 - <b>PMC</b> Detergente disinfettante pronto all'uso (diluito 2,5%)	18,00
	AC241	DK-SAN - Lt. 5 - <b>PMC</b> Detergente disinfettante concentrato Da diluire dal 2,5 al 5%	108,00







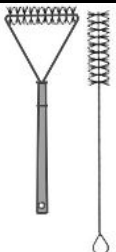

Detergenti liquidi per batterie alettate e filtri.

Possono essere anche utilizzati nella pulizia di locali caldaia, pezzi meccanici ed altro.







**SCOVOLI PER PULIZIA CALDAIE**

			EURO
	SA040	Kit scovoli per murali Confezione Pz. 10 misure assortite	55,00
	SA019	Scovolini pulizia Ø30mm L=cm.100 - Ottone	6,00
	SA020	Scovolini pulizia Ø35mm L=cm.100 - Nylon	7,00

**GUARNIZIONI, SIGILLANTI E PRODOTTI****Guarnizioni esenti amianto**

			<b>EURO</b>
	GG006	Guarnizione 1/8" Confezione Pz.10 <b>Confezione Pz.100</b>	2,00 <b>18,00</b>
	GG005	Guarnizione 1/4" Confezione Pz.10 <b>Confezione Pz.100</b>	2,00 <b>18,00</b>
	GG004	Guarnizione 3/8" Confezione Pz.10 <b>Confezione Pz.100</b>	2,00 <b>18,00</b>
	GG001	Guarnizione 1/2" Confezione Pz.10 <b>Confezione Pz.100</b>	2,00 <b>18,00</b>
	GG002	Guarnizione 3/4" Confezione Pz.10 <b>Confezione Pz.100</b>	3,00 <b>25,00</b>
	GG003	Guarnizione 1" Confezione Pz.10 <b>Confezione Pz.100</b>	4,00 <b>32,00</b>
	GG010	In gomma per bocchettoni 1" - Confezione Pz.10 Spessore mm.3	4,00
	GG011	In gomma per bocchettoni 1"1/2 - Confezione Pz.10 Spessore mm.3	6,00

**\*Per confezioni da Pz. 1000 prezzi speciali\*****Sigillanti**





			<b>EURO</b>
	RF205	TEFLON DVGW uso gas Bobina PTFE 1/2"	2,00
	RF204	TEFLON DVGW uso gas Bobine PTFE 1/2" <b>Confezione Nr.10</b>	12,00
	RF208	TEFLON ROSA -Tmax 140° Bobina PTFE 1/2" <b>Per alta temperatura adatto per impianti solari e vapore</b>	8,00
	RF203	TEFLON Bobina PTFE 3/4" gialla A norma DIN-DVGW	10,00
	RF220	LOCTITE 55 - mt.150 Sigillafiletti a filo di teflon omologato DVGW	29,00
	RF207	NASTRO alluminio adesivo h.50 mm x mt.50	22,00
	RF209	FACOT - Silicon Tape Sigillante ad effetto dinamico Adatto per alte temperature	10,00

**SILICON SEALING TAPE**

E' un nastro in fibra sintetica impregnato con un particolare mastice non indurente. Sigilla raccordi filettati di qualunque diametro e materiale, adatto per gas (vapore, GPL, metano), acqua potabile, acidi, riscaldamento e pannelli solari.

E' un sigillante dinamico in quanto si adatta a tutti i filetti ed a qualsiasi materiale ed è **riposizionabile** anche a distanza di anni.

**Sigillanti**

			<b>EURO</b>
	RF200	Sigillafiletti anaerobico LOXEAL 58-11 100 ml. DIN-DVGW	42,00
	RF212	Guarnizione liquida LOXEAL 58-31 75 ml Temperatura - 55 / + 150°C	39,00
	RF210	Attivatore spray LOXEAL 11 Acceleratore di indurimento dei sigilla filetti - 200 ml.	29,00
	SA160	SALDASYSTEM Stucco bicomponente Riparatutto-rapido. Anche sott'acqua. Indurisce in pochi minuti.	18,00

**LOXEAL 58-11**







Utilizzato in sostituzione di canapa o teflon, è omologato per gas, GPL ed acqua potabile, a norme DIN/DVGW. Indurisce in 15/30 minuti.

(5 minuti abbinato a LOXEAL11)

**LOXEAL 58-31**

Sigilla le superfici piane, sostituisce le guarnizioni preformate con una elastica e flessibile, recupera fino a 5 decimi di mm. Indurisce in 30 minuti.

**Prodotti e lubrificanti**

			<b>EURO</b>
	SP104	ECOFUGHE - ml.400 Rilevatore fughe gas spray	9,00
	SP113	TOP REVEL GAS - ml.400 Rilevatore fughe gas spray <b>NON INFIAMMABILE</b>	21,00
	SA352	SILIC SPRAY - ml.400 Lubrificante non oleoso al silicone	14,00
	SA355	WD40 - ml.400 Disossidante lubrificante professionale	19,00
	SA356	CHEM SP17 - ml.400 Solvente per elettronica Elimina lo sporco senza lasciare residui né aggredire i materiali di supporto	30,00
	SA162	ECONET - Erogatore ml.750 Spray sgrassante <b>Adatto per mantelli delle caldaie e i pavimenti delle centrali termiche</b>	18,00
	GR564	Grasso al silicone MS4 Tubetto gr.25	7,00